



**“Emozionare oltre la funzione come solo l’atto creativo sa fare. Elevare il gusto e trasmettere la cultura del glassware e del tableware professionale dando il massimo risalto al contenuto quanto al contenitore.”**

Italesse dà vita ai propri prodotti studiandone ogni dettaglio, traducendo la funzionalità in emozioni percepite attraverso il gusto e la vista. Know-how professionale e cultura del design guidano ogni atto creativo dell’azienda.

Con l’avvento del progetto Senses, Italesse ha rivoluzionato i prodotti professionali per il mondo del vino introducendo per prima il concetto dei calici sensoriali, calici cioè capaci di valorizzare le sensazioni organolettiche di ciascun vino, superando il concetto, non più adeguato, del calice varietale. La strada intrapresa da Italesse ha ricevuto il plauso degli operatori del settore quali enologi, sommelier e giornalisti, portandola ad essere azienda italiana leader del calice sensoriale.

**“To excite beyond function as only the creative act can. To elevate taste and convey the culture of professional glass and tableware, giving the same emphasis to the product’s contents as to the product itself.”**

Italesse creates its products by studying every single detail, translating functionality into emotions perceived through taste and sight. Professional know-how and design culture lead every creative act of the company.

With the launch of the Senses project, Italesse has revolutionized the world of professional wine products by being the first to introduce the concept of sensory stem glasses, able to enhance the organoleptic sensations of every wine, going beyond the inappropriate concept of the varietal stem glass. This new path embarked by Italesse has received the plaudits of many experts in the industry, including enologists, sommeliers, and journalists, making it the Italian leading company of the sensory stem glass.

# Indice / Contents

## 06 Azienda / Company

## 15 Collezioni / Collections

16	T-made Collection
18	Masterclass Collection
24	Etoilé Collection
30	Etoilé Sparkle
32	Balloon Collection
34	Richard Juhlin Optimum
36	Wormwood Collection
40	Cloud Tumbler
42	Twist Tumbler Collection
46	Vertigo Tumbler
50	Mares Collection
56	Sfera
58	Tiburón Collection
62	Vertical Collection
66	Riviera & Flute N°5
68	Levante
72	Bora Collection
74	Easy Collection
75	Master & Mastro
76	Vinocchio
78	Alavin
80	Vertigo Decanter
82	Tonic Glass
84	Kodama Tumbler
88	Go Go
90	Premium Collection
92	Beach Collection
96	Kodama Beach Tumbler
100	Moonlight & Sunlight Collection
102	Bolle Beach Tumbler
104	Air Beach Collection
108	Fresnel Collection
110	Tonic Beach
111	Pachà Beach Light

## Collezioni / Collections

112	Kodama Bucket & Bowl
116	Magnolia Buckets & Bowls
120	Timber Bucket & Bowl
122	Plaza Bucket & Bowl
124	Bolle Bucket & Bowl
128	Vela Bucket & Bowl
132	Tonic Ice Bucket & Bowl
134	Easy Buckets & Bowls
136	Bongo Bucket & Bowl
138	Stainless Steel Collection
142	Aria
144	Wine 360°
146	Lollipop
148	Ocean Stopper
149	Fiesta Stopper

## 151 Portfolio

## 157 Designers & Opinion Leaders

# Azienda / Company



## DNA professionale

## Professional DNA

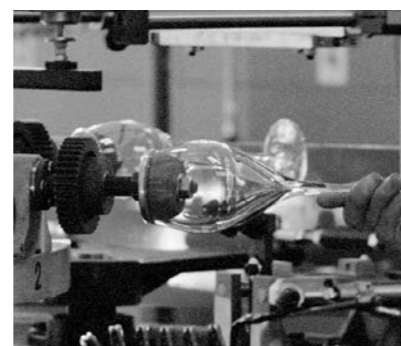

Fondata nel 1979, Italesse individua da subito, nel mercato del beverage, una carenza di articoli professionali destinati a valorizzare prodotti come vini e alcolici e, allo stesso tempo, supportare le vendite di brand affermati come strumenti di comunicazione e di immagine. Da un'attenta ricerca tecnica nascono così le prime serie di calici, bicchieri, decanter, glacette, e con il tempo viene proposta una gamma completa ed esclusiva di accessori e bottiglie che impongono l'azienda all'attenzione dei più rinomati produttori di vini, champagne ed alcolici internazionali. In breve tempo il marchio vede crescere la propria diffusione anche grazie alla crescente richiesta da parte di hotel, resort e ristoranti che ne decretano il posizionamento nel mondo professionale. Obiettivi chiari, una strategia aziendale coraggiosa e in controtendenza con i tempi che, nella produzione di oggetti premium destinati ad una fascia di mercato medio/alta, radica un'identità aziendale forte, ulteriormente avvalorata da un concept produttivo fondante: fare del binomio forma/funzione la base di una costante ricerca tecnica e formale - materiali innovativi, applicazione del colore, tecnologie all'avanguardia.

L'attenzione di Italesse ai dettagli, all'efficienza tecnica professionale dei prodotti, nonché verso l'atto creativo, grazie anche ad importanti collaborazioni con designer, sommelier ed enologi di fama internazionale è, ormai da tempo, affiancata dall'impegno verso temi come l'etica e l'ambiente che ci circonda. Impegno che è stato premiato con la medaglia d'argento EcoVadis, prestigioso riconoscimento internazionale relativo alla sostenibilità.

After its establishment in 1979, Italesse soon noticed a lack of products designed to enhance wine and spirits as well as support the image and sales of well-established brands in the complex beverage market at once. For this reason, after thorough research, the first series of stemware, glasses, carafes, and decanters were produced. After some time, a wide and exclusive range of other accessories and high-end bottles followed, which have placed Italesse in the highest ranks among international wine, champagne, and spirits producers. In a short time, the brand grew thanks to its success in the hotel, resort, and restaurant world thus entering the Horeca market in which Italesse immediately spotted great potential. Italesse's strong business identity, based on clear objectives and bold countertrend business strategies, is focused on premium products for the medium to high-end market.

These qualities are intertwined with a fundamental production concept using form and function as the foundation for all research, whether it be in innovative materials, ergonomic shapes, the use of colors, or ground-breaking technologies. For some time now, the company's attention to detail, high quality materials, professional and technical efficiency of the products, as well as creativity have aligned with Italesse's awareness of ethics and the environmental concerns that surround us. This engagement was awarded with the EcoVadis silver medal, a prestigious international award relating to sustainability.

## I valori dell'azienda

## Company values

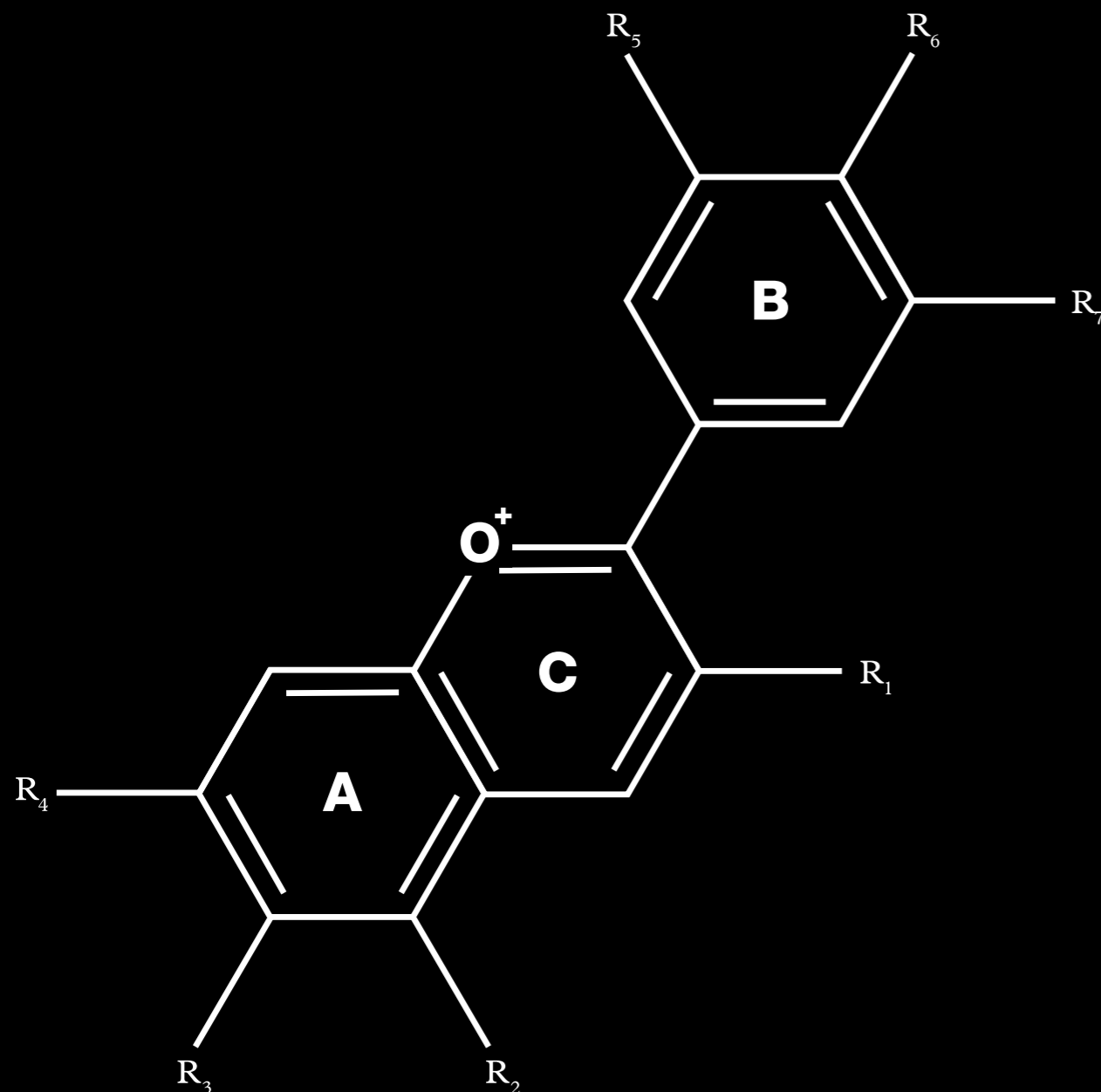

**L'azione di Italesse, dalla fase creativa a quella della vendita dei prodotti, è guidata da una serie di scelte, valori e obiettivi.**

**Design.** La nostra azienda pone attenzione verso il design dei propri prodotti, verso forme che caratterizzino l'oggetto facendolo divenire espressione d'arte ed elemento di arredo acquisendo un proprio valore anche indipendente dalla funzione ma senza mai volutamente slegarlo dalla funzione stessa, che rimane centrale.

**Efficienza tecnica.** Nell'atto di creazione dei nostri prodotti, la forma, pur importante, non può mai slegarsi dalla funzione dell'oggetto, anzi proprio l'efficienza tecnica dell'oggetto stesso è l'obiettivo principale. Proprio questa caratteristica pone i nostri prodotti fra quelli più apprezzati nel mondo professionale.

**Attenzione ai dettagli.** Design, efficienza tecnica e natura professionale dei prodotti sono elementi per noi raggiungibili solo ponendo attenzione ai minimi dettagli, dalla progettazione fino alla produzione.

**Qualità dei materiali.** Per Italesse, ogni sforzo creativo e tecnico è vano se nell'atto produttivo non vengono impiegati materiali di qualità.

**Ricerca dell'emozionalità nella percezione sensoriale dei prodotti.** Per Italesse un prodotto non è finito se "oltre ad essere bello e funzionale" non riesce ad avere un'altra caratteristica importante: saper emozionare in qualunque modo possibile, attraverso le sensazioni organolettiche o tattili percepite nell'utilizzo dello stesso o attraverso il gioco delle forme e il loro impatto alla vista.

**Etica, ambiente e sostenibilità.** L'attenzione verso chi lavora con noi, chi sceglie i nostri prodotti e l'ambiente che ci circonda caratterizzano le nostre azioni aziendali. Italesse è costantemente impegnata a garantire processi produttivi sicuri, tutelare i diritti e le pari opportunità dei lavoratori, realizzare prodotti non nocivi per l'uomo, cercando, allo stesso tempo, di contribuire al rispetto dell'ambiente, impegnandosi a realizzare sempre più prodotti sostenibili, packaging ottenuti da materiali riciclati e investendo nella ricerca di nuovi bio-materiali e materiali riciclati, oltre che in processi che mirino alla riduzione delle emissioni di CO<sub>2</sub>.

**Italesse's action, from the creative phase to the sale of its products, is guided by a series of choices, values and objectives.**

**Design.** Our company pays close attention to the design of the products, aiming at creating shapes that are perfectly distinguishable, and transforming them into art expressions and décor elements. Therefore, every design acquires its own value, independently from its function but without ever deliberately separating it from it, as it remains central.

**Technical efficiency.** In the act of creating our products, the form, although important, can never be separated from the function of the object. Indeed, our main goal is creating products that are technically efficient. This characteristic places our products among the most appreciated in the professional world.

**Attention to details.** Design, technical efficiency, and professional nature of the products are results that can only be achieved by paying attention to the smallest details, from the design of the product to its production.

**Quality of materials.** For Italesse, all creative and technical efforts are futile if high quality materials are not used in the production process.

**Search for emotions in the sensory perception of products.** For Italesse, a product cannot be said to be finished if, in addition to being beautiful and functional, it fails to have another important characteristic: being able to excite in every possible way, through the organoleptic or tactile sensations perceived in its use or through the play of shapes and their visual impact.

**Ethics, environment and sustainability.** Attention to those who work with us, our customers, and the environment around us characterise our corporate activity. Italesse is constantly committed to guaranteeing safe production processes, protecting the rights and equal opportunities of workers, making products that are not harmful to humans, while at the same time respecting the environment, committing to the production of sustainable products and investing in the research of new bio- and recycled materials, which are also used for the packaging of our products.

## Senses, saper innovare andando oltre le convenzioni

Recentemente Italesse ha ulteriormente ampliato il proprio savoir-faire professionale relativo al mondo del vino con Senses, un progetto che ha come obiettivo finale quello di coniugare emozioni ed eccellenza tecnica nella degustazione. Il team di Italesse Senses ha rivoluzionato il modo di immaginare e progettare i prodotti partendo dalla destrutturazione dei vini in aromi testando, ad esempio, i calici, sia con il vino, che direttamente con ribes, lamponi, pepe nero; e apportando essenziali modifiche e micro-modifiche alla struttura del bicchiere, per migliorare proprio le percezioni sensoriali ed olfattive. Questo lavoro ha permesso ad Italesse di andare oltre l'idea del calice varietale, concetto non più adeguato alle esperienze degustative in tempi in cui la cultura e la conoscenza del vino si è elevata raggiungendo anche il mercato consumer. Partendo dal concetto che ogni vino è unico e, ad esempio, un pinot nero di una regione è a volte molto diverso da quello di un'altra o si sceglie il bicchiere in base alle caratteristiche organolettiche di ciascun vino, indipendentemente dalle convenzioni, oppure bisogna pensare ad un calice di tipo sartoriale, cucito "addosso" ad una determinata etichetta, ad uno stile produttivo o ad un terroir (cosa oggi portata avanti in Italesse grazie al progetto T-made). Superato il concetto di bicchiere varietale Italesse introduce quello del calice sensoriale, un calice che rispetta l'unicità di ogni singolo vino e le sensazioni organolettiche ad esso legate.

## Designing around aromas: going beyond the varietal - specific glass

Lately, Italesse further expanded its professional savoir-faire related to the wine world with the new Senses project, which aims at combining emotions and technical excellence in the tasting experience. The Italesse Senses team completely transformed the way the products are designed and imagined, deconstructing the individual wines into aromas by testing, for instance, the stem glass directly with wine as well as with only currants, raspberries, and black pepper. In this process, the most important changes are made - sometimes even incredibly tiny ones - to the stem glass structure, which greatly improves sensorial and olfactory perceptions. The work done by the Italesse Senses team goes beyond the idea of the varietal stem glass, a concept no longer suitable in times in which the culture and knowledge of wine has risen, reaching the consumer market as well. Because every wine is unique, like a Pinot Noir can differ greatly from one region to another, either we choose the glass based on the organoleptic characteristics of each wine, regardless of the conventions, or we have to think of a tailor-made glass, "sewn on" a specific label, a production style or a terroir (a project carried on today in Italesse thanks to the T-made Lab). By going beyond the concept of the varietal stem glass, Italesse establishes the idea of the sensory stem glass, which respects the uniqueness of every single wine and its own organoleptic sensations.

# **Collezioni / Collections**



## T-made Collection

*Una nuova collezione di calici professionali dalle prestazioni tecniche eccezionali, progettati grazie agli studi sui terroir e le sensazioni organolettiche dei vini | A new collection of professional stem glasses of extraordinary technical performances, designed after several studies on the terroir and organoleptic sensations of specific wines*

design by ITALESSE



**IT** T-made 70 e T-made 55 introducono la nuovissima T-made collection, una serie di calici che derivano dal progetto Senses e sono il frutto del lavoro compiuto dal T-made Lab. Questo ultimo è un team di Italesse che si pone lo scopo di realizzare, accanto a Consorzi o anche singoli produttori, calici appositamente disegnati, con un approccio sartoriale, sui terroir e le sensazioni organolettiche di specifici vini ed essere strumenti tecnici unici e dalle performance straordinarie. T-made 70 e T-made 55, grazie alle loro linee, risultano ideali per vini rossi e bianchi particolarmente strutturati, complessi ed eleganti, perfetti per la degustazione professionale ma allo stesso tempo straordinari nell'utilizzo quotidiano.

**EN** T-made 70 and T-made 55 introduce the new T-made collection, a series of stem glasses that originate from the Senses project and were later realized by the T-made Lab. The T-made Lab is an Italesse team that works with syndicates or independent winemakers in realizing stem glasses especially designed on the terroir and organoleptic sensations of specific wines with a sartorial approach. Thanks to this approach, these stem glasses become true technical and unique tools of extraordinary performance. T-made 70 and T-made 55, because of their shapes, are best suited for red and white wines of great structure, complexity, and elegance, they're perfect to be used in professional tastings and at the same time for an everyday use.



### T-MADE 70 EXCELLENCE

art. 3302

MATERIALE / MATERIAL  
Vetro cristallino Excellence  
soffiato a bocca e lavorato  
a mano / Excellence mouth  
blown, hand-crafted, lead-free  
crystal glass

CAPACITÀ / CAPACITY  
710 cc / 24 oz

COLORI / COLOURS  
Clear

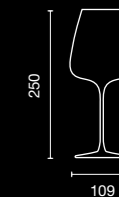

250

109

### T-MADE 70 XTREME\*

art. 3303

MATERIALE / MATERIAL  
Vetro cristallino Xtreme® soffiato  
in automatico in assenza  
di piombo / Lead free automatically  
blown crystalline Xtreme® glass

CAPACITÀ / CAPACITY  
710 cc / 24 oz

COLORI / COLOURS  
Clear

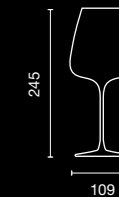

245

109

### T-MADE 55 EXCELLENCE

art. 3301

MATERIALE / MATERIAL  
Vetro cristallino Excellence  
soffiato a bocca e lavorato  
a mano / Excellence mouth  
blown, hand-crafted, lead-free  
crystal glass

CAPACITÀ / CAPACITY  
560 cc / 19 oz

COLORI / COLOURS  
Clear



231

105

### T-MADE 55 XTREME\*

art. 3325

MATERIALE / MATERIAL  
Vetro cristallino Xtreme® soffiato  
in automatico in assenza  
di piombo / Lead free automatically  
blown crystalline Xtreme® glass

CAPACITÀ / CAPACITY  
560 cc / 19 oz

COLORI / COLOURS  
Clear



230

103



## Masterclass Collection

*Per i professionisti della degustazione, la collezione Masterclass è progettata per esaltare l'approccio sensoriale di ogni vino, sovvertendo l'idea del calice varietale con quella del calice emozionale.*

*La collezione è disponibile in vetro Excellence o Xtreme® | For tasting professionals, Masterclass Collection is designed to enhance the sensorial approach of each wine, subverting the varietal stemware idea with that of the emotional stemware. The Collection is available in Excellence crystal glass or Xtreme®*

design by ITALESSE



**IT** Calici studiati per offrire le migliori prestazioni professionali possibili ed esaltare l'approccio visivo, olfattivo e gustativo del vino. La collezione è realizzata in vetro cristallino Excellence, soffiato a bocca e lavorato a mano, o in vetro Xtreme®, soffiato a macchina, straordinario per resistenza. Il nuovissimo Masterclass 28, come i Masterclass 22 e 42, è progettato per valorizzare al meglio le sensazioni organolettiche di champagne e vini spumanti. La collezione è completata da Masterclass 48, 50, 70 e 90. Il design è un punto inciso a laser alla base della coppa, che valorizza il perlage, rendono Masterclass 48 adatto per servire anch'esso Champagne e

spumanti, e al tempo stesso vini rosé e bianchi freschi. Masterclass 50 è un calice eccellente per esaltare vini bianchi ma anche rossi particolarmente eleganti e freschi. Il Masterclass 70 è perfetto per degustare champagne complessi, bianchi corposi e rossi giovani ed eleganti. Masterclass 90, dalle forme generose ed eleganti, è un calice studiato per vini rossi pregiati e corposi, ma straordinario anche per bianchi strutturati e complessi che richiedono una particolare ossigenazione. Alla collezione di calici si aggiunge infine il Masterclass Tumbler, straordinario per l'eleganza delle forme e per l'estrema leggerezza.

**EN** Stemware designed to offer the best performance as well as enhance the approach to wine in terms of visual appearance, smell, and taste. The Collection is realized in Excellence mouth-blown and handmade crystal glass or in Xtreme® extraordinarily resilient crystal glass. Our newest Masterclass 28, like Masterclass 22 and 42, was designed to enhance the organoleptic sensations of champagnes and sparkling wines. The collection is completed by Masterclass 48, 50, 70, and 90. The design and a laser cut point on the piqure that valorizes the perlage make Masterclass 48 a stem glass ideal to serve

Champagne and sparkling wines as well as rosé wines and fresh whites. Masterclass 50 is an excellent stem glass that enhances particularly fresh and elegant whites and reds alike. Masterclass 70 is perfect for tasting complex champagnes, structured whites as well as young and elegant reds. Masterclass 90, with its generous and elegant shapes, designed for structured and refined red wines, is also suited to enhance structured and complex whites that need a particular oxygenation. Lastly, the collection includes the Masterclass Tumbler, extraordinary for its elegant shapes and extreme lightness.





## MASTERCLASS 42 EXCELLENCE

art. 3386

MATERIALE / MATERIAL  
Vetro cristallino Excellence  
soffiato a bocca e lavorato a mano /  
Excellence mouth-blown  
hand-crafted crystalline glass

CAPACITÀ / CAPACITY  
445 cc / 15 oz

COLORI / COLOURS  
Clear



## MASTERCLASS 90 EXCELLENCE

art. 3367

MATERIALE / MATERIAL  
Vetro cristallino Excellence  
soffiato a bocca e lavorato a mano /  
Excellence mouth-blown  
hand-crafted crystalline glass

CAPACITÀ / CAPACITY  
950 cc / 32 oz

COLORI / COLOURS  
Clear



## MASTERCLASS 70 EXCELLENCE

art. 3366

MATERIALE / MATERIAL  
Vetro cristallino Excellence  
soffiato a bocca e lavorato a mano /  
Excellence mouth-blown  
hand-crafted crystalline glass

CAPACITÀ / CAPACITY  
720 cc / 24 1/4 oz

COLORI / COLOURS  
Clear



## MASTERCLASS TUMBLER EXC.

art. 3375

MATERIALE / MATERIAL  
Vetro cristallino Excellence soffiato a  
bocca e lavorato a mano /  
Excellence mouth-blown hand-crafted  
crystalline glass

CAPACITÀ / CAPACITY  
460 cc / 15 1/2 oz

COLORI / COLOURS  
Clear

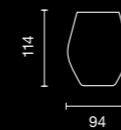

## MASTERCLASS 48 EXCELLENCE

art. 3365

MATERIALE / MATERIAL  
Vetro cristallino Excellence  
soffiato a bocca e lavorato a mano /  
Excellence mouth-blown  
hand-crafted crystalline glass

CAPACITÀ / CAPACITY  
480 cc / 16 1/4 oz

COLORI / COLOURS  
Clear



## MASTERCLASS 42 XTREME\*

art. 3381

MATERIALE / MATERIAL  
Vetro cristallino Xtreme\* /  
Xtreme\* crystalline glass

CAPACITÀ / CAPACITY  
445 cc / 15 oz

COLORI / COLOURS  
Clear



## MASTERCLASS 90 XTREME\*

art. 3364

MATERIALE / MATERIAL  
Vetro cristallino Xtreme\* /  
Xtreme\* crystalline glass

CAPACITÀ / CAPACITY  
950 cc / 32 oz

COLORI / COLOURS  
Clear



## MASTERCLASS 70 XTREME\*

art. 3366

MATERIALE / MATERIAL  
Vetro cristallino Xtreme\* /  
Xtreme\* crystalline glass

CAPACITÀ / CAPACITY  
720 cc / 24 1/4 oz

COLORI / COLOURS  
Clear



## MASTERCLASS 50 XTREME\*

art. 3375

MATERIALE / MATERIAL  
Vetro cristallino Xtreme\* /  
Xtreme\* crystalline glass

CAPACITÀ / CAPACITY  
520 cc / 18 oz

COLORI / COLOURS  
Clear



## MASTERCLASS 48 XTREME\*

art. 3362

MATERIALE / MATERIAL  
Vetro cristallino Xtreme\* /  
Xtreme\* crystalline glass

CAPACITÀ / CAPACITY  
480 cc / 16 1/4 oz

COLORI / COLOURS  
Clear



## MASTERCLASS 28 XTREME\*

art. 3387

MATERIALE / MATERIAL  
Vetro cristallino Xtreme\* /  
Xtreme\* crystalline glass

CAPACITÀ / CAPACITY  
290 cc / 9 3/4 oz

COLORI / COLOURS  
Clear



## MASTERCLASS 22 XTREME\*

art. 3382

MATERIALE / MATERIAL  
Vetro cristallino Xtreme\* soffiato in  
automatico in assenza di piombo /  
Lead free automatically blown  
crystalline Xtreme\* glass

CAPACITÀ / CAPACITY  
230 cc / 7 3/4 oz

COLORI / COLOURS  
Clear





## Etoilé Collection

*Elegante, sinuosa, di classe, curata nei dettagli per rendere l'esperienza d'uso emozionale: è così che la Collezione Etoilé si presenta sulle tavole dei ristoranti stellati e più raffinati. Grazie allo stile e alle performance gli Etoilé sono diventati i calici ufficiali dell'Associazione Maîtres Cuisiniers de France | Elegant, sinuous, fancy, studied in all details to give a full emotional experience: this is how the Etoilé Collection presents itself on the tables of the most refined and renowned Michelin-starred restaurants. The style and the performances of the Etoilé stem glasses have earned them the title of official stemware of the Maîtres Cuisiniers de France Association*

**IT** Progettati per superare il concetto di bicchiere varietale, gli Etoilé sono calici professionali che esaltano le proprietà organolettiche di tutte le tipologie di vino. Etoilé Blanc è ideale per esaltare la freschezza dei vini bianchi, il d'Or è una flûte di tipo tradizionale pensata per godere l'intensità di Champagne e spumanti, il Noir è un calice perfetto per i rossi giovani ed

eleganti mentre il Platinum ha proporzioni pensate per esaltare i vini bianchi e rossi di struttura. Il calice Sparkle si presenta invece come una vera rivoluzione per il mondo della degustazione di spumanti e Champagne: coppa più ampia, corpo elegantemente alto e ben sette punti di perlage.

**EN** Designed to overcome the varietal stemware concept, the Etoilé are professional stem glasses that enhance the organoleptic characteristics of all types of wine. Etoilé Blanc is ideal to enhance the freshness of white wines, Etoilé D'Or is a traditional flûte designed to enjoy the intensity of champagnes and sparkling wines, Etoilé Noir is a stem glass perfect for young and elegant

wines, while Etoilé Platinum's proportions are designed to enhance structured white and red wines. Etoilé Sparkle, instead, is a revolution in tasting champagnes and sparkling wines with its wider bowl, elegant height, and seven perlage points. Etoilé Cristal tumbler, extraordinary for water, completes the collection.





## ETOILÉ NOIR EXCELLENCE

art. 3347

MATERIALE / MATERIAL  
Vetro cristallino Excellence  
soffiato a bocca e lavorato a mano /  
Excellence mouth blown,  
hand-crafted, lead-free crystal glass

CAPACITÀ / CAPACITY  
760 cc / 25 3/4 oz (Excellence)  
790 cc / 26 3/4 oz (Xtreme®)

COLORI / COLOURS  
Clear



## ETOILÉ BLANC EXCELLENCE

art. 3346

MATERIALE / MATERIAL  
Vetro cristallino Excellence  
soffiato a bocca e lavorato a mano /  
Excellence mouth blown,  
hand-crafted, lead-free crystal glass

CAPACITÀ / CAPACITY  
550 cc / 18 1/2 oz (Excellence)  
570 cc / 19 1/4 oz (Xtreme®)

COLORI / COLOURS  
Clear



## ETOILÉ SPARKLE EXCELLENCE

art. 3062

MATERIALE / MATERIAL  
Vetro cristallino Excellence  
soffiato a bocca e lavorato a mano /  
Excellence mouth blown,  
hand-crafted, lead-free crystal glass

CAPACITÀ / CAPACITY  
480 cc / 16 1/2 oz

COLORI / COLOURS  
Clear



230  
98

## ETOILÉ D'OR EXCELLENCE

## ETOILÉ PLATINUM EXCELLENCE

art. 3075

MATERIALE / MATERIAL  
Vetro cristallino Excellence  
soffiato a bocca e lavorato a mano /  
Excellence mouth blown,  
hand-crafted, lead-free crystal glass

CAPACITÀ / CAPACITY  
660 cc / 22 1/4 oz

COLORI / COLOURS  
Clear



## ETOILÉ D'OR EXCELLENCE

art. 3057

MATERIALE / MATERIAL  
Vetro cristallino Excellence  
soffiato a bocca e lavorato a mano /  
Excellence mouth blown,  
hand-crafted, lead-free crystal glass

CAPACITÀ / CAPACITY  
330 cc / 11 oz

COLORI / COLOURS  
Clear

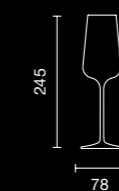

245  
78



## ETOILÉ NOIR XTREME®

art. 3361

MATERIALE / MATERIAL  
Vetro cristallino Xtreme® soffiato in  
automatico in assenza di piombo /  
Lead free automatically blown  
crystalline Xtreme® glass

CAPACITÀ / CAPACITY  
760 cc / 25 3/4 oz (Excellence)  
790 cc / 26 3/4 oz (Xtreme®)

COLORI / COLOURS  
Clear



## ETOILÉ BLANC XTREME®

art. 3360

MATERIALE / MATERIAL  
Vetro cristallino Xtreme® soffiato in  
automatico in assenza di piombo /  
Lead free automatically blown  
crystalline Xtreme® glass

CAPACITÀ / CAPACITY  
550 cc / 18 1/2 oz (Excellence)  
570 cc / 19 1/4 oz (Xtreme®)

COLORI / COLOURS  
Clear

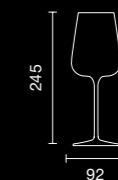

## ETOILÉ SPARKLE XTREME®

art. 3055

MATERIALE / MATERIAL  
Vetro cristallino Xtreme® soffiato in  
automatico in assenza di piombo /  
Lead free automatically blown  
crystalline Xtreme® glass

CAPACITÀ / CAPACITY  
480 cc / 16 1/2 oz

COLORI / COLOURS  
Clear



230  
98

# Etoilé Sparkle

*Un calice che ha il sapore della sfida e il fascino dell'innovazione. Etoilé Sparkle è un prodotto unico, ideato da Luca Bini e dedicato alla degustazione degli spumanti ottenuti con metodo classico | A stem glass that carries with it the spirit of challenge and the wonder of innovation. Etoilé Sparkle is a unique stem glass, conceived by Luca Bini and intended for the tasting of sparkling wines realized using the classic method*

design by LUCA BINI



## Chiusura della bocca stretta

Pensata per convogliare l'aroma dei vini verso il naso e la bocca.

**Narrow closure of the rim.** Thought to convey the wine's aroma to the nose and mouth.

## Fondo piano e larghezza della coppa

Studiato per permettere al perlage di salire in superficie e raccogliere aromi e profumi, esaltando tutte le caratteristiche organolettiche del vino.

**Flat base and cup width.** Studied to allow the perlage to rise to the surface as well as collect aromas and scents, glorifying all the organoleptic qualities of the wine.

## Punti perlage

Sparkle propone un innovativo sistema di perlage, basato su sette punti incisi a laser, in grado di accrescerlo, animando così il vino e intensificando l'esperienza della degustazione.

**Perlage points.** Sparkle proposes an innovative perlage system, based on seven laser-engraved dots, able to enhance it and thus animate the wine, intensifying the tasting experience.

## Fascino e tecnica

L'eleganza del gambo unisce fascino e tecnica permettendo di posizionare la mano alla giusta distanza dal calice, garantendo l'ottimale temperatura di degustazione.

**Glamour and technique.** The elegance of the stem unites glamour and technique, allowing the hand to be positioned a suitable distance from the body of the glass, guaranteeing an optimal tasting temperature.



## Altezza della coppa e pareti affusolate

Ideata per dirigere il vino direttamente alla lingua e consentire una valutazione immediata della qualità del vino.

**Height of the glass and tapered walls.** Designed to guide wine directly to the tongue, allowing for an immediate evaluation of the quality of the wine.

### ETOILÉ SPARKLE EXCELLENCE

art. 3062

MATERIALE / MATERIAL  
Vetro cristallino Excellence soffiato a bocca e lavorato a mano / Excellence mouth blown, hand-crafted, lead-free crystal glass

CAPACITÀ / CAPACITY  
480 cc / 16 1/2 oz

COLORI / COLOURS  
Clear



### ETOILÉ SPARKLE EXTREME®

art. 3055

MATERIALE / MATERIAL  
Vetro cristallino Xtreme® soffiato in automatico in assenza di piombo / Lead free automatically blown crystalline Xtreme® glass

CAPACITÀ / CAPACITY  
480 cc / 16 1/2 oz

COLORI / COLOURS  
Clear





## Balloon Collection

*Flûte che rievocano le forme dei calici da vino tradizionali balloon, realizzati per una proposta di servizio innovativo in linea con le nuove tendenze di degustazione e di consumo del mondo dello Champagne - scenico ed elegante | Flutes that evoke the silhouette of traditional wine tasting balloon glasses and deliver an innovative proposal for service that follows the latest tasting and consumption trends in Champagne - dramatic, sophisticated*

design by ITALESSE



**IT** La serie Balloon, realizzata in vetro Xtreme, si compone di due calici: Balloon Flûte e Grand Balloon Flûte, progettati per valorizzare gli aromi di champagne e vini spumanti. Una profonda piqûre, con un punto perlage inciso al laser, esalta la finezza e la persistenza delle bollicine.

**EN** The Balloon collection, realized in Xtreme glass, is composed of two stem glasses: Balloon Flûte and Grand Balloon Flûte, designed to enhance the aromas of sparkling wines and champagne. A deep piqûre, featuring a laser-engraved dot, enhances the finesse and persistence of the perlage.



GRAND BALLOON FLÛTE XTREME®

art. 3036

MATERIALE / MATERIAL  
Vetro Xtreme® soffiato in automatico in assenza di piombo / Automatically blown, lead free Xtreme® glass

CAPACITÀ / CAPACITY  
380 cc / 12 ¾ oz

COLORI / COLOURS  
Clear

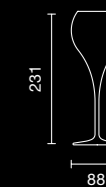

BALLOON FLÛTE XTREME®

art. 3035

MATERIALE / MATERIAL  
Vetro Xtreme® soffiato in automatico in assenza di piombo / Automatically blown, lead free Xtreme® glass

CAPACITÀ / CAPACITY  
210 cc / 7 oz

COLORI / COLOURS  
Clear

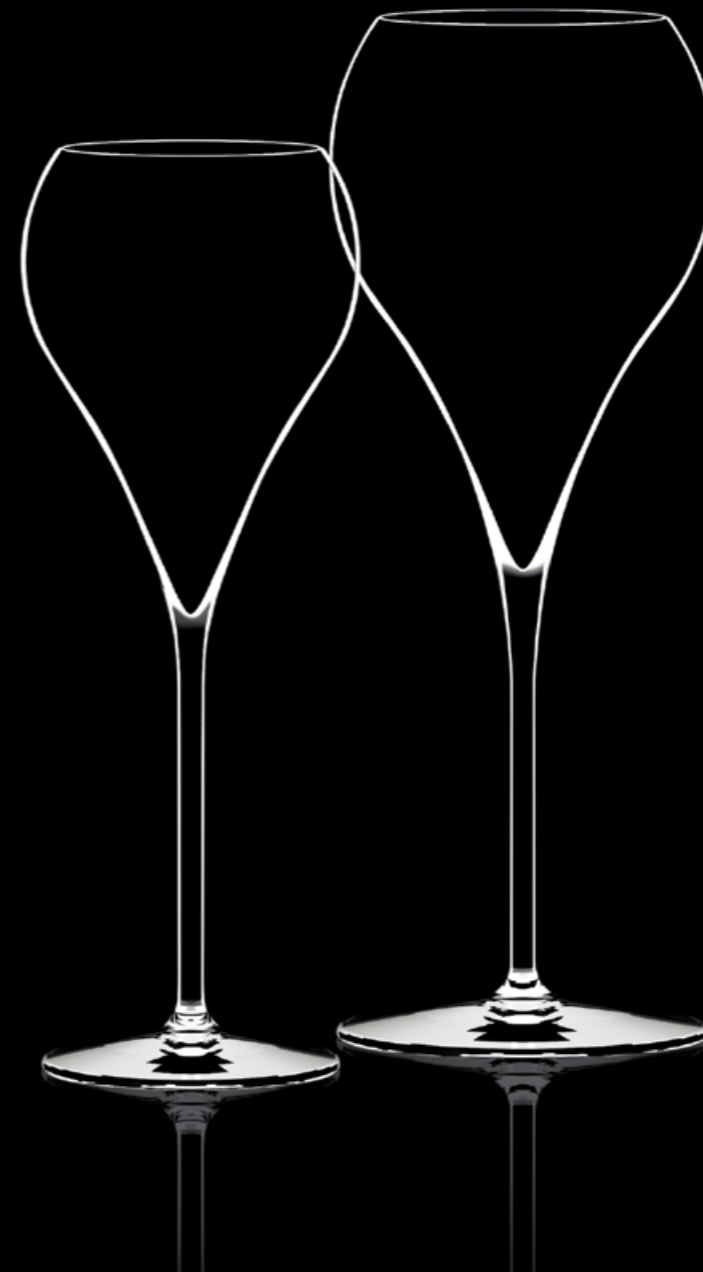
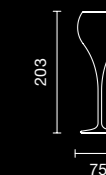

# Richard Juhlin Optimum

*Flûte professionale per la degustazione dello Champagne: da un'intuizione di Italesse, il calice Optimum prende forma grazie alla collaborazione di Richard Juhlin, uno dei massimi esperti internazionali di Champagne, con Claesson Koivisto Rune, uno dei più apprezzati atelier di design nel mondo | A professional Flûte based on the intuition of Italesse, the Richard Juhlin Optimum has taken shape thanks to the collaboration between Richard Juhlin, one of the top international Champagne experts, and Claesson Koivisto Rune, one of the most appreciated design firms in the world*

concept by RICHARD JUHLIN  
design by CLAESSON KOIVISTO RUNE



## Diametro della bocca

Il bevande è proporzionato all'altezza e all'angolo della coppa. La bocca è chiusa tanto quanto basta per permettere allo Champagne di indirizzare al naso fragranze e aromi nel migliore modo possibile.

**Mouth diameter.** The rim is proportional to the height and angle of the bowl. It is closed just enough to allow the Champagne to direct the fragrances and aromas perfectly towards the taster's nose.

## Ampiezza della coppa

Il diametro massimo della coppa corrisponde al livello ottimale di servizio: è quell'ottimale superficie di Champagne, che esposta all'aria sovrastante e contenuta nella coppa, rilascia gli aromi e le fragranze nel modo più efficace possibile. È a questo livello (9cl.) che è stata apposta (su una versione del calice da Champagne) una linea decorativa e funzionale.

**Bowl width.** The maximum diameter of the bowl corresponds to an optimal quantity and surface area exposure of Champagne to the air. This is the "Juhlin line", the ideal measurement for releasing Champagne aromas and fragrances in the best possible manner.

## Punto Perlage e piqûre

Il fondo della coppa del calice ospita una profonda piqûre, dove si formano le bollicine (propagate al centro della coppa) e dove il punto laser perlage moltiplica l'effetto, generando una maggiore quantità di bollicine.

**Perlage Point and Piqûre.** The bowl depth is conceived to favour perlage in the center of the glass, for perfect tasting. Inside the piqûre, on the bottom, there is a circular ring comprising numerous small micro-incisions on the glass surface: this is the perlage point. When the Champagne is poured into the glass long bubble chains are produced (known as perlage) and the effect is long-lasting.

## Altezza della coppa

La dimensione totale della coppa è studiata tecnicamente ed è perfettamente bilanciata. Sia nella profondità della picure nella parte bassa, che nell'altezza e nell'angolazione di chiusura della coppa nella parte superiore – detta cheminée – per concentrare e canalizzare gli aromi e i profumi verso il naso e la bocca.

**Bowl Height.** Perfectly balanced dimensions along the entire height of the glass, both at the bottom, in terms of the depth of the piqûre, and in the angle of the cheminée, i.e. the angle at which the bowl gradually closes. A technically impeccable shape: the generosity of the "Juhlin line" enhances the virtues of champagne, while the significantly taller cheminée ensures the right distance for tasting, concentrating the aromas and fragrances of the champagne to the perfect intensity and channeling them harmoniously towards nose and mouth.

## Curva rientrante

La base della coppa ha una curva rientrante, che oltre a definirne la forma tecnica, esalta l'identità del calice e le dona quel tocco di contemporaneità imprescindibile.

**Inward Curve.** The extreme delicacy of the glass that sinuously coils towards the stem designs a light, gentle curve and gives the RJ Optimum a unique iconic identity.



RICHARD JUHLIN OPTIMUM

art. 3056

MATERIALE / MATERIAL  
Vetro cristallino /  
Crystalline glass

CAPACITÀ / CAPACITY  
290 cc / 9 3/4 oz

COLORI / COLOURS  
Clear



## Wormwood Collection

*Italesse presenta una delle collezioni cocktail più celebri e apprezzate al mondo, in grado di fondere un accattivante design in un prodotto tecnico e innovativo dedicato ai Bartender professionisti, ai Cocktail Bar premium e al mondo dell'Ospitalità | Italesse presents one of the world's most renowned and appreciated cocktail collections that combine appealing design with highly technical and innovative product concepts. Dedicated to cocktail professionals, premium bars, and the hospitality world*

design by LUCA TRAZZI  
concept by GIANCARLO MANCINO



**IT** Con Wormwood Italesse propone ai professionisti una linea mixology estremamente elegante, in linea con le tendenze attuali ed in particolare con il revival ispirato alla Belle Epoque. Questa collezione rappresenta la sintesi tra un oggetto emozionale, con un design forte, e un prodotto tecnico. Wormwood è il risultato della collaborazione con uno dei più noti opinion leader del settore cocktail, Giancarlo Mancino e con il designer Luca Trazzi: due personalità forti, che hanno saputo unire un'estetica ricercata a un design in grado di valorizzare le creazioni cocktail.

**EN** Italesse offers cocktail professionals a cocktail and dining collection in harmony with current trends that echo the revival of the roaring twenties. The Wormwood collection is the synthesis of a strong, emotional design and a fundamentally technical product. Wormwood is the result of the collaboration between one of the most distinguished opinion leaders of the cocktail world, Giancarlo Mancino and the renowned designer Luca Trazzi. These two strong personalities have ingeniously combined an intricate aesthetic with a design that elevates mixed drink creations.



**IT** La collezione Wormwood si compone di sei calici e bicchieri pensati per il mondo dei grandi cocktail bar e la degustazione che garantisce un servizio originale ed elegante, dall'atmosfera retro pur con linee contemporanee. Completa la collezione il Gallone, un grande bicchiere a tulipano utilizzato dai barman per preparare interi cocktail miscelati, o più porzioni dello stesso cocktail contemporaneamente. Italesse ha scelto di arricchire tutti gli elementi della collezione Wormwood con un decoro inciso che richiama la pianta (artemisia) di assenzio. Volute di rami e foglie valorizzano le forme, creando un'ambientazione che sa essere contemporanea e di grande effetto, rendendo unica la presentazione dei cocktail.

**EN** The Wormwood collection is composed of six glasses and stem glasses conceived for the world of grand cocktail bars and tasting that guarantees an innovative and elegant service that has retro feel yet is contemporary in its forms. The Gallone completes the classic cocktail collection, a large tulip-shaped mixing glass used by bartenders to mix cocktails or to make more than one serving of the same drink at a time. Italesse has embellished the collection with a decorative pattern, an ethereal engraving whose motif features the absinthe (wormwood) plant. Spiraling branches and leaves heighten the glassware's forms, contemporary and highly effective, rendering cocktail presentation truly original.



## WORMWOOD GALLONE

art. 1404

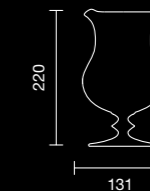
MATERIALE / MATERIAL  
Vetro soffiato a bocca /  
Mouth-blown glassCAPACITÀ / CAPACITY  
1000 cc / 33 ¾ ozCOLORI / COLOURS  
Clear Pattern

## WORMWOOD ALTO-BALL

art. 3352

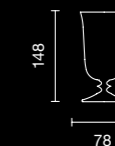
MATERIALE / MATERIAL  
Vetro cristallino /  
Crystalline glassCAPACITÀ / CAPACITY  
310 cc / 10 ½ ozCOLORI / COLOURS  
Clear Pattern

## WORMWOOD DOUBLE PRESIDENTE

art. 3372

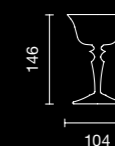
MATERIALE / MATERIAL  
Vetro cristallino /  
Crystalline glassCAPACITÀ / CAPACITY  
220 cc / 7 ½ ozCOLORI / COLOURS  
Clear Pattern

## WORMWOOD ASTORIA

art. 3371

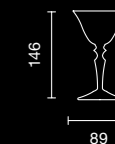
MATERIALE / MATERIAL  
Vetro cristallino /  
Crystalline glassCAPACITÀ / CAPACITY  
130 cc / 4 ½ ozCOLORI / COLOURS  
Clear Pattern

## WORMWOOD PRESIDENTE

art. 3370

MATERIALE / MATERIAL  
Vetro cristallino /  
Crystalline glassCAPACITÀ / CAPACITY  
135 cc / 4 ½ ozCOLORI / COLOURS  
Clear Pattern

## WORMWOOD ROCK-GOBLER

art. 3351

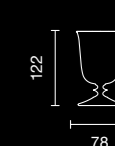
MATERIALE / MATERIAL  
Vetro cristallino /  
Crystalline glassCAPACITÀ / CAPACITY  
230 cc / 7 ¾ ozCOLORI / COLOURS  
Clear Pattern

# Cloud Tumbler

*Linee sinuose ma decise per un tumbler dalla grande presenza scenica | Sinuous but determined shapes for a tumbler of great visual impact*

design by ITALESSE



**IT** Cloud tumbler, grazie al suo design pulito, fatto di linee sinuose ma decise, è un tumbler perfetto per completare il servizio in tavola in modo moderno e con personalità.

**EN** Cloud tumbler, thanks to its design that consists of sinuous but determined shapes, is the perfect tumbler to complete the mise en place with a touch of modernity and personality.



## CLOUD TUMBLER EXCELLENCE

**art. 3377**

MATERIALE / MATERIAL  
**Vetro cristallino Excellence soffiato a bocca e lavorato a mano / Excellence mouth blown, hand-crafted, lead-free crystal glass**

CAPACITÀ / CAPACITY  
**370 cc / 12 ½ oz**

COLORI / COLOURS  
**Clear**

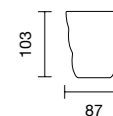

## CLOUD TUMBLER XTREME\*

**art. 3378**

MATERIALE / MATERIAL  
**Vetro cristallino Xtreme® soffiato in automatico in assenza di piombo / Lead free automatically blown crystalline Xtreme® glass**

CAPACITÀ / CAPACITY  
**370 cc / 12 ½ oz**

COLORI / COLOURS  
**Clear**

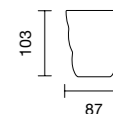

## Twist Tumbler Collection

*Una collezione di tumbler dal design unico, dinamica e allo stesso tempo raffinata | A tumbler collection with a unique design, dynamic and sophisticated at the same time*

design by ITALESSE



**IT** Dopo il successo di Pua, la collezione si arricchisce con i nuovi Twist e Twist Pua Amber, anche essi realizzati in vetro soffiato a bocca e lavorato a mano da esperti mastri vetrai. L'innovativo design a "torchon" e i pois rendono questi bicchieri estremamente dinamici ed eleganti, perfetti per servire acqua e altre bevande in modo brioso ma raffinato.

**EN** After Pua's success, the collection has expanded and now it includes the new Twist and Twist Pua Amber, both handmade in mouth-blown glass by expert glass masters. The innovative twisted design and the polka dots make this tumbler very elegant and dynamic, extremely suitable for serving water and other drinks with a touch of energy and style.



#### TWIST TUMBLER

art. 3376

MATERIALE / MATERIAL  
Vetro borosilicato soffiato a bocca,  
lavorato a mano / Mouth-blown  
hand-crafted borosilicate glass

CAPACITÀ / CAPACITY  
370 cc / 12 ½ oz

COLORI / COLOURS  
Clear

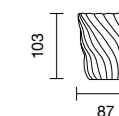

#### TWIST PUA TUMBLER

art. 3354

MATERIALE / MATERIAL  
Vetro borosilicato soffiato a bocca,  
lavorato a mano / Mouth-blown  
hand-crafted borosilicate glass

CAPACITÀ / CAPACITY  
370 cc / 12 ½ oz

COLORI / COLOURS  
Clear & White



Clear & Amber

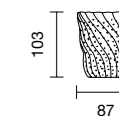

## Vertigo Tumbler

*Classe ed eleganza nella lavorazione artistica del vetro soffiato colorato / Elegance and class in the artistic craftsmanship of mouth-blown colored glass*

design by ITALESSE





**IT** Bicchieri unici e di grande raffinatezza, realizzati in vetro soffiato a bocca e lavorati a mano da esperti mastri vetrai. Un'innovativa spirale caratterizza Vertigo Tumbler con delle scanalature sia interne che esterne, impreziosendolo ulteriormente in termini di dinamicità e colorazione. Vertigo Tumbler è disponibile in più colori, con capacità 380 cc. Un bicchiere ideale per la tavola e perfetto per servire acqua e altre bevande con straordinaria eleganza.

**EN** Unique and refined drinking glasses made of mouth-blown, hand crafted glass by expert master craftsmen. An innovative spiral design characterizes the Vertigo Tumbler creating internal and external ridges that enliven the glass further with dynamism and color. Vertigo tumbler is available in various hues and has a capacity of 380 cc. This collection is ideal for sophisticated table settings and serving other beverages with extraordinary elegance.

## VERTIGO TUMBLER

art. 3353

MATERIALE / MATERIAL  
Vetro colorato soffiato a bocca e lavorato a mano / Mouth-blown, hand-crafted coloured glass

CAPACITÀ / CAPACITY  
380 cc / 12 ¾ oz

COLORI / COLOURS

Clear &amp; White    Black &amp; White



Blue &amp; White

Amber &amp; White



Green &amp; White

Red &amp; White

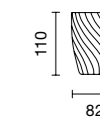

## Mares Collection

*Nata per stupire e realizzata a mano da mastri vetrai orientali, la linea Mares è composta da coloratissimi bicchieri, shot e bowl creati con una tecnica produttiva che ha radici antiche | Hand Made by oriental glassware craftsmen to astonish and surprise, the Mares Tumblers are extremely colorful glasses, shots and bowls produced using manual manufacturing techniques with ancient roots*

design by ITALESSE



**IT** La collezione Mares è nata per stupire. Realizzati a mano da mastri vetrai orientali, tumbler e shot sono creati con una tecnica produttiva che ha radici antiche. Oggetti preziosi, soffiati a bocca utilizzando melange di paste di vetro colorate, i tumbler e gli shot sono veri e propri pezzi unici (in un giorno ne vengono realizzati solo sessanta). Uno diverso dall'altro, decorano la tavola e la rendono singolare ed indimenticabile. La collezione Mares propone colori scelti pensando al mondo subacqueo delle barriere coralline, dove l'esplosione di nuances di piante e pesci tropicali ammalia e sorprende. La particolarità di questi prodotti risiede proprio nella capacità di attrarre l'attenzione: da bicchieri sanno trasformarsi in oggetti decorativi perfetti in tavola anche come ornamenti artistici.

**EN** The Mares collection is made to surprise. Hand Made by oriental glassware craftsmen, the Mares Tumblers and are produced using manual manufacturing techniques with ancient roots. The collection includes a series of tumblers and shots made of mouth-blown colored glass paste melanges using a technique that allows for up to a maximum of only sixty pieces a day. Completely different from one another, these glasses decorate the table rendering it truly singular and unforgettable. The Mares collection proposes a series of hues that are inspired by the underwater world of coral reefs where the explosion of the nuances of colored plants and tropical fish amaze and surprise. The uniqueness of these glasses lies in their capacity to draw attention of the onlooker, from glasses they transform themselves in decorative elements that are perfect on the table given their truly ornamental quality.

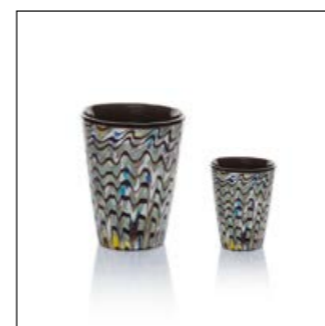

Mares Tumbler, Mares Tumbler Shot

#### MARES TUMBLER

art. 3355

MATERIALE / MATERIAL  
Pasta di vetro colorato soffiato a bocca e lavorato a mano / Hand-crafted mouth-blown colored glass paste

CAPACITÀ / CAPACITY  
310 cc / 10 ½ oz

COLORI / COLOURS

Angel Fish	Tiger Fish
<b>Star Fish</b>	<b>Napoleon Fish</b>
<b>Jelly Fish</b>	<b>Clown Fish</b>
<b>Argus Fish</b>	<b>Parrot Fish</b>
<b>Shell Fish</b>	<b>Sea Bass Fish</b>
<b>Oyster Fish</b>	<b>Bluefin Fish</b>

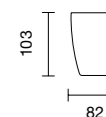

#### MARES TUMBLER SHOT

art. 3356

MATERIALE / MATERIAL  
Pasta di vetro colorato soffiato a bocca e lavorato a mano / Hand-crafted mouth-blown colored glass paste

CAPACITÀ / CAPACITY  
53 cc / 1 ¾ oz

COLORI / COLOURS

Angel Fish	Tiger Fish
<b>Star Fish</b>	<b>Napoleon Fish</b>
<b>Jelly Fish</b>	<b>Clown Fish</b>
<b>Argus Fish</b>	<b>Sea Bass Fish</b>
<b>Oyster Fish</b>	<b>Bluefin Fish</b>

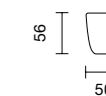

**IT** La collezione Mares si arricchisce di nuove bowl colorate e affascinanti. Le Mares Bowls sono anch'esse realizzate a mano da mastri vetrai orientali, create con una tecnica produttiva che ha radici antiche. La collezione si compone di un set di bowl più grande adatta a servire appetizers, finger food, insalate o dolci al cucchiaio e di una più piccola pensata per piccole prelibatezze, o salse e condimenti. Oggetti preziosi e divertenti, soffiati a bocca utilizzando gli stessi melange di paste di vetro colorate dei tumbler: in un giorno ne vengono realizzati solo pochi pezzi, e sono pezzi unici. Una diversa dall'altra, decorano la tavola e la rendono singolare ed indimenticabile. La collezione Mares propone colori scelti pensando al mondo subacqueo delle barriere coralline, dove l'esplosione di nuances di piante e pesci tropicali ammalia e sorprende.

**EN** The Mares collection is enriched by new colorful and fascinating bowls. Both handmade by oriental glassware craftsmen, are extremely produced using manual manufacturing techniques with ancient roots. The collection includes a series of larger bowls ideal to serve appetizers, finger food, salads or sweets and a smaller series designed for condiments or little sweets. Precious and fun, mouth-blown with the tumbler's same colored glass paste melanges using a technique that allows only a few pieces a day. Completely different from one another, these bowls decorate the table rendering it truly singular and unforgettable. The Mares collection proposes a series of hues that are inspired by the underwater world of coral reefs where the explosion of the nuances of colored plants and tropical fish amaze and surprise.



Mares Bowl N.11, Mares Bowl N.8

MARES BOWL N.11

art. 5082

MATERIALE / MATERIAL  
Pasta di vetro colorato soffiato a bocca  
e lavorato a mano / Hand-crafted  
mouth-blown colored glass paste

COLORI / COLOURS  
Napoleon Fish

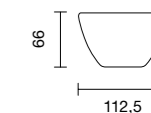

MARES BOWL N. 8

art. 5081

MATERIALE / MATERIAL  
Pasta di vetro colorato soffiato a bocca  
e lavorato a mano / Hand-crafted  
mouth-blown colored glass paste

COLORI / COLOURS  
Star Fish    Napoleon Fish



Clown Fish

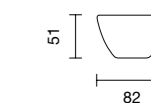

# Sfera

*Bicchieri multiuso in vetro con base in gomma colorata utile alla gestione dell'inclinazione per un servizio fantasioso / Multi-purpose glass with a colored rubber base on which to tilt the glass for a creative service*

design by MINEDIVINE



**IT** La Collezione Sfera propone un bicchiere multifunzionale di forma sferica e imboccatura ampia per distillati e liquori che permette un comodo utilizzo anche per finger food, dolci al cucchiaio e piccole prelibatezze cucinate direttamente nel forno. Sfera è dotato di una base piatta che consente di appoggiarlo con sicurezza sul piano. L'anello in gomma soffice, permette di posizionarlo secondo l'inclinazione preferita. A completare la collezione e offrire un set di servizio più completo si aggiungono altri due bicchieri di dimensioni sempre più piccole per piccoli dolci al cucchiaio, condimenti o salse.

**EN** The Sfera Collection offers a multifunctional glass with a spherical shape and a wide mouth for distillates and liqueurs, perfect also for innovative finger food presentation, desserts and small delicacies cooked directly in the oven. Sfera has a flat base so it can be placed safely on flat surfaces. The silicone base allows the glass to be at a specific angle as preferred. To complete the collection and offer a complete service set we include two more glasses of smaller dimensions for sweets, condiments or creams.

SFERA N. 11

art. 3330

MATERIALE / MATERIAL  
Vetro borosilicato soffiato a bocca, lavorato a mano e gomma soffice colorata base / Mouth-blown hand-crafted borosilicate glass and soft-coloured rubber base

CAPACITÀ / CAPACITY  
580 cc / 19 3/4 oz

COLORI / COLOURS  
Clear

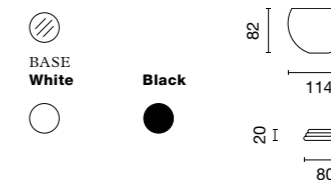

SFERA N. 7

art. 3332

MATERIALE / MATERIAL  
Vetro borosilicato soffiato a bocca, lavorato a mano / Mouth-blown hand-crafted borosilicate glass

CAPACITÀ / CAPACITY  
120 cc / 4 oz

COLORI / COLOURS  
Clear

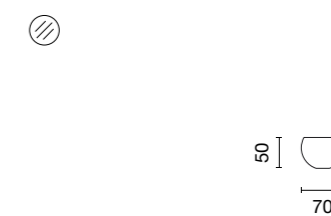

SFERA N. 9

art. 3333

MATERIALE / MATERIAL  
Vetro borosilicato soffiato a bocca, lavorato a mano e gomma soffice colorata base / Mouth-blown hand-crafted borosilicate glass and soft-coloured rubber base

CAPACITÀ / CAPACITY  
295 cc / 10 oz

COLORI / COLOURS  
Clear

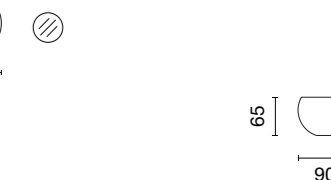

SFERA N. 5

art. 3331

MATERIALE / MATERIAL  
Vetro borosilicato soffiato a bocca, lavorato a mano / Mouth-blown hand-crafted borosilicate glass

CAPACITÀ / CAPACITY  
70 cc / 2 1/4 oz

COLORI / COLOURS  
Clear

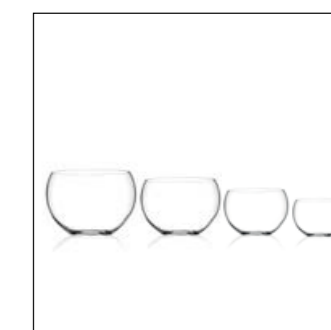

Sfera Collection

## Tiburón Collection

*Una linea di calici e bicchieri creati per la degustazione professionale, caratterizzata da linee aggressive ed eleganti |  
A line of wine glasses and tumblers for professional tastings, characterised by aggressive yet elegant forms*

design by ITALESSE



**IT** La linea Tiburón, collezione che deve l'ispirazione delle sue curve ardite ed aggressive alla forma di un potente squalo, è formata da pregiati calici e bicchieri. I calici della collezione presentano una piqûre dalla linea profonda e tagliente concepita per percepire la reale colorazione del vino, mentre la coppa ne esalta la massa. La sciancratura della parte bassa della coppa permette, inoltre, che il vino si sviluppi nella parte superiore, favorendone l'ossigenazione. Realizzati con la tecnologia brevettata Xtreme® e grazie ai contorni angolati, questi calici risultano altamente resistenti. La collezione si completa con i Tiburón Bar e Tumbler per servire acqua, birre e cocktail.

**EN** The Tiburón collection of stemware and tumblers stands out in the crowd with its bold and aggressive shapes inspired by the great shark. The stem glasses in this collection feature a deep-piqûre highlighting wine's true color, while the wide bowl enhances the wine's body. The large width of the bowl allows the wine to develop the top portion of the glass, elevating oxygenation levels. Made with Italesse's patented Xtreme® technology, the angled contours of the stemware reinforce the resistance of the glass against breakage. Possessing the same Xtreme® technology, Tiburón Tumbler completes the collection and is perfect for serving water.



## TIBURÓN LARGE

art. 3340

MATERIALE / MATERIAL  
Vetro cristallino Xtreme® soffiato in automatico in assenza di piombo / Xtreme crystalline® automatic blown glass with no lead

CAPACITÀ / CAPACITY  
620 cc / 21 oz

COLORI / COLOURS  
Clear

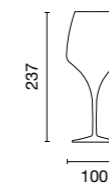

## TIBURÓN MEDIUM

art. 3341

MATERIALE / MATERIAL  
Vetro cristallino Xtreme® soffiato in automatico in assenza di piombo / Xtreme crystalline® automatic blown glass with no lead

CAPACITÀ / CAPACITY  
500 cc / 16 2/3 oz

COLORI / COLOURS  
Clear



## TIBURÓN TUMBLER

art. 3342

MATERIALE / MATERIAL  
Vetro colorato soffiato a bocca e lavorato a mano / Mouth-blown, hand-crafted coloured glass

CAPACITÀ / CAPACITY  
350 cc / 11 3/4 oz

COLORI / COLOURS  
Black Transp. Blue

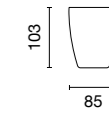



## Vertical Collection

*Una linea di calici e tumbler tecnici e polifunzionali,  
adatti a tutte le tavole | A technical and multifunctional  
glassware range, suited to every table*



**IT** Vertical è la collezione di calici e tumbler in vetro cristallino Xtreme® dall'eleganza raffinata e dalle caratteristiche altamente tecniche. La linea è formata da calici vino e flûte pensati per la degustazione di grandi vini. I calici sono dotati di una profonda piqûre per favorire il perlage e grazie all'accurato design, risultano adatti a molteplici utilizzi. I calici Vertical sono realizzati con tecnologia Xtreme®, caratteristica che rende la collezione altamente resistente e quindi adatta ad ogni ambiente e situazione, anche le più "estreme", per aperitivi, cene e feste all'insegna dello stile e della sicurezza. Vertical si completa con un tumbler polifunzionale, perfetto per servire acqua, soft drink e colorati cocktail.

**EN** Vertical is a collection of refined and elegant crystalline Xtreme® glasses with highly technical features. The line consists of wine glasses and flutes for serving and tasting of fine wines. The wine glasses of the Vertical Collection feature a special piqûre that enhances perlage and their carefully studied design renders them suitable for multiple applications. Produced using Xtreme® technology glass, optimum performance and high resistance to breakage is guaranteed with this glassware range, making this collection particularly suitable for all environments and settings, including "extreme" situations: apéritifs, cocktail parties and dinners to be enjoyed in style and absolute safety. The Vertical Line is completed by a multifunctional tumbler perfect for serving water, soft-drinks and colorful cocktails.



## VERTICAL LARGE

art. 3304

MATERIALE / MATERIAL  
Vetro cristallino Xtreme® soffiato in automatico in assenza di piombo / Xtreme® Crystalline automatic blown glass with no lead

CAPACITÀ / CAPACITY  
500 cc / 16 ¾ oz

COLORI / COLOURS  
Clear



## VERTICAL MEDIUM

art. 3308

MATERIALE / MATERIAL  
Vetro cristallino Xtreme® soffiato in automatico in assenza di piombo / Xtreme® Crystalline automatic blown glass with no lead

CAPACITÀ / CAPACITY  
390 cc / 13 oz

COLORI / COLOURS  
Clear



## PRIVÉ GRAN CRU

art. 3049

MATERIALE / MATERIAL  
Vetro cristallino Xtreme® soffiato in automatico in assenza di piombo / Xtreme® Crystalline automatic blown glass with no lead

CAPACITÀ / CAPACITY  
330 cc / 11 oz

COLORI / COLOURS  
Clear

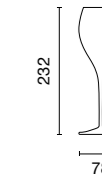

## PRIVÉ FLÛTE

art. 3048

MATERIALE / MATERIAL  
Vetro cristallino Xtreme® soffiato in automatico in assenza di piombo / Xtreme® Crystalline automatic blown glass with no lead

CAPACITÀ / CAPACITY  
150 cc / 5 oz

COLORI / COLOURS  
Clear



## MASTER

art. 3309

MATERIALE / MATERIAL  
Vetro / Glass

CAPACITÀ / CAPACITY  
290 cc / 9 ¾ oz

COLORI / COLOURS  
Clear

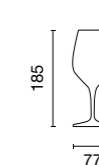

## VERTICAL PARTY

art. 3310

MATERIALE / MATERIAL  
Vetro cristallino soffiato in automatico in assenza di piombo / Crystalline automatic blown glass with no lead

CAPACITÀ / CAPACITY  
420 cc / 14 ¼ oz

COLORI / COLOURS  
Clear White

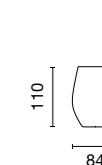

## Riviera & Flûte N°5

*Riviera & Flûte N°5 sono due flûte Italesse di grande successo, scelti da piccoli e grandi produttori di spumanti e Champagne che ne apprezzeranno la forma raffinata e l'elevata prestazione tecnica | Riviera & Flûte N°5 are two Italesse flutes that have become very successful, as they are often chosen by small and big producers of champagne and sparkling wines who appreciate the elegant shape and the technical performance of these flutes*

design by ITALESSE



**IT** Riviera è una flûte da degustazione per Champagne e vini frizzanti, moderna, resistente e dalla forte personalità. Gambo slanciato e punto perlage inciso a laser in una profonda piquère, la rendono una flûte distintiva. Ideale in una degustazione professionale, è declinato in tre capacità, risultando il calice ideale per ogni esigenza di servizio. Il modello da 14 cl, in particolare, ben si presta a servire vini dolci, grappe, distillati d'uva e liquori. Capacità superiori per Flûte N°5, flûte professionale da degustazione dal design pulito e minimale con coppa stretta e gambo sottile ma molto resistente, da 28 cc.

**EN** Riviera is a tasting flute for Champagnes and sparkling wines, modern, resistant and with a strong personality. A slender stem and a laser-engraved perlage point in its deep pique make this a distinctive flute. Ideal for professional tastings, it is available in two different sizes, which makes it the ideal flute for all service needs. The 14 cl model is especially well suited for the service of sweet wines, digestifs and liqueurs. Flûte N°5 with a capacity of 28 cc, is a flûte for professional tasting with a clean and minimal design, a narrow bowl and a thin, yet very strong stem.



### FLÛTE N°5

art. 3059

MATERIALE / MATERIAL  
Vetro cristallino Xtreme® soffiato in automatico in assenza di piombo / Xtreme® Crystalline automatic blown glass with no lead

CAPACITÀ / CAPACITY  
280 cc / 9 ½ oz

COLORI / COLOURS  
Clear

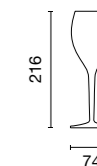

### RIVIERA 17

art. 3070

MATERIALE / MATERIAL  
Vetro / Glass

CAPACITÀ / CAPACITY  
170 cc / 5 ¾ oz

COLORI / COLOURS  
Clear



### RIVIERA 14

art. 3068

MATERIALE / MATERIAL  
Vetro / Glass

CAPACITÀ / CAPACITY  
140 cc / 4 ¾ oz

COLORI / COLOURS  
Clear

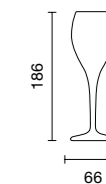

# Levante

*Calice dalle performance tecniche avanzate, perfetto per l'uso quotidiano | A stem glass able to offer advanced technical performances, perfect for an intense daily use*

design by ITALESSE



**IT** Grazie all'esperienza maturata dall'azienda sui calici professionali nasce Levante, un calice polifunzionale, dalle linee eleganti e originali, adatto all'intenso uso quotidiano ma comunque caratterizzato da performance tecniche avanzate, utili a godere appieno le varie caratteristiche dei vini.

**EN** Thanks to the experience gained in designing professional stem glasses, was born Levante, a multi-purpose stem glass featuring an elegant and original design, perfect for an intense daily use while at the same time able to offer technical performances to fully appreciate the characteristics of all wines.

LEVANTE

**art. 3390**

MATERIALE / MATERIAL  
**Vetro / Glass**

CAPACITÀ / CAPACITY  
**500 cc / 16 2/3 oz**

COLORI / COLOURS  
**Clear**



## Bora Collection

*La linea Bora è una collezione di calici polifunzionali dalle linee essenziali e performance avanzate | The Bora Line is a range of multifunctional stem glasses characterized by advanced performance and essential lines*

design by ITALESSE



**IT** Una linea di due calici, il Medium e il Large, che si contraddistingue per robustezza, grazie alla tecnologia pull-stem. Il bevante sottile di questi calici ottenuto dal taglio a laser, garantisce una nuova esperienza della degustazione, più piacevole e più raffinata, e che rende la linea Bora adatta per tutti i tipi di vini.

**EN** A line of stem glasses consisting of two elements, Bora Medium and Bora Large, distinguished by robustness thanks to the pull-stem technology used to make them. Bora's delicate, laser-cut rim heightens the tasting experience rendering it more enjoyable and sophisticated, making it suitable for serving all types of wine.

BORA LARGE

art. 3323

MATERIALE / MATERIAL  
Vetro / Glass

CAPACITÀ / CAPACITY  
500 cc / 16 ¾ oz

COLORI / COLOURS  
Clear

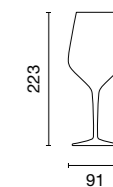

BORA MEDIUM

art. 3324

MATERIALE / MATERIAL  
Vetro / Glass

CAPACITÀ / CAPACITY  
390 cc / 13 oz

COLORI / COLOURS  
Clear

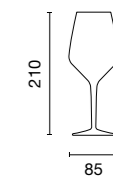

## Easy Collection

*Calici da vino dalle linee semplici ed armoniose ma con valenze tecnicamente performanti, perfetti per la degustazione professionale / Wine stemware line with simple proportions and shapes that deliver high performance, ideal for professional tasting*

design by ITALESSE

**IT** I calici della linea Easy sono convenienti e performanti e si declinano in diverse capacità: Easy Large, per degustazioni di vini e/o aperitivi, la sua versione più alta Easy Large Plus, calice dalle forme semplici e armoniose con gambo sottile e allungato, adatto a servire vini complessi ed eleganti ed Easy Medium, dalle dimensioni più ridotte, per degustare vini più freschi e giovani

**EN** The Easy line is composed of convenient and high performance wine stem glasses. Easy Large is ideal to be used in wine tastings or in serving aperitifs. Its taller version, Easy Large Plus, with its simple and harmonious shape and its thin, elongated stem it's ideal to serve complex and elegant wines. Easy Medium, smaller in size, is ideal for tasting fresher and younger wines



### EASY LARGE PLUS

art. 3368

MATERIALE / MATERIAL  
**Vetro / Glass**

CAPACITÀ / CAPACITY  
**500 cc / 16 ¾ oz**

COLORI / COLOURS  
**Clear**



### EASY LARGE

art. 3321

MATERIALE / MATERIAL  
**Vetro / Glass**

CAPACITÀ / CAPACITY  
**500 cc / 16 ¾ oz**

COLORI / COLOURS  
**Clear**



### EASY MEDIUM

art. 3320

MATERIALE / MATERIAL  
**Vetro / Glass**

CAPACITÀ / CAPACITY  
**380 cc / 12 ¾ oz**

COLORI / COLOURS  
**Clear**



## Master & Mastro

*Due calici adatti al servizio professionale, ideali per le situazioni e gli ambienti del mondo del vino e della birra che richiedono particolare resistenza / Two stem glasses apt for professional service, ideal for serving wine and beer in all those situations and environments that require high resistance*

design by ITALESSE

**IT** Il calice polifunzionale Master, presenta linee pulite e semplici ed è dotato di particolare robustezza per offrire ottime performance di servizio. È perfetto per degustare tutti i tipi di vino, ma anche per servire aperitivi in modo originale e con stile. Mastro è un calice universale in vetro per la degustazione della birra. Ideato per esaltare la schiuma, il gusto e consentire il pieno sviluppo degli aromi della birra. Resistente, è perfetto per l'utilizzo professionale.

**EN** Master, multifunctional stem glass with clean and linear forms is particularly robust to offer excellent service performance. It is ideal for serving all types of wines as well as original aperitifs with style. Mastro is a universal stemware for beer tasting. Designed for enhancing the foam and the taste, it allows the correct development of beer's aromas. Resistant, it is perfect for professional use.



### MASTER

art. 3309

MATERIALE / MATERIAL  
**Vetro / Glass**

CAPACITÀ / CAPACITY  
**290 cc / 9 ¾ oz**

COLORI / COLOURS  
**Clear**



### MASTRO

art. 3369

MATERIALE / MATERIAL  
**Vetro / Glass**

CAPACITÀ / CAPACITY  
**420 cc / 14 ¼ oz**

COLORI / COLOURS  
**Clear**



# Vinocchio

*Decanter in vetro soffiato dalle caratteristiche altamente professionali e dallo stile contemporaneo | Mouth-blown glass decanter with highly professional features and a contemporary style*

design by FEDERICO VENIER

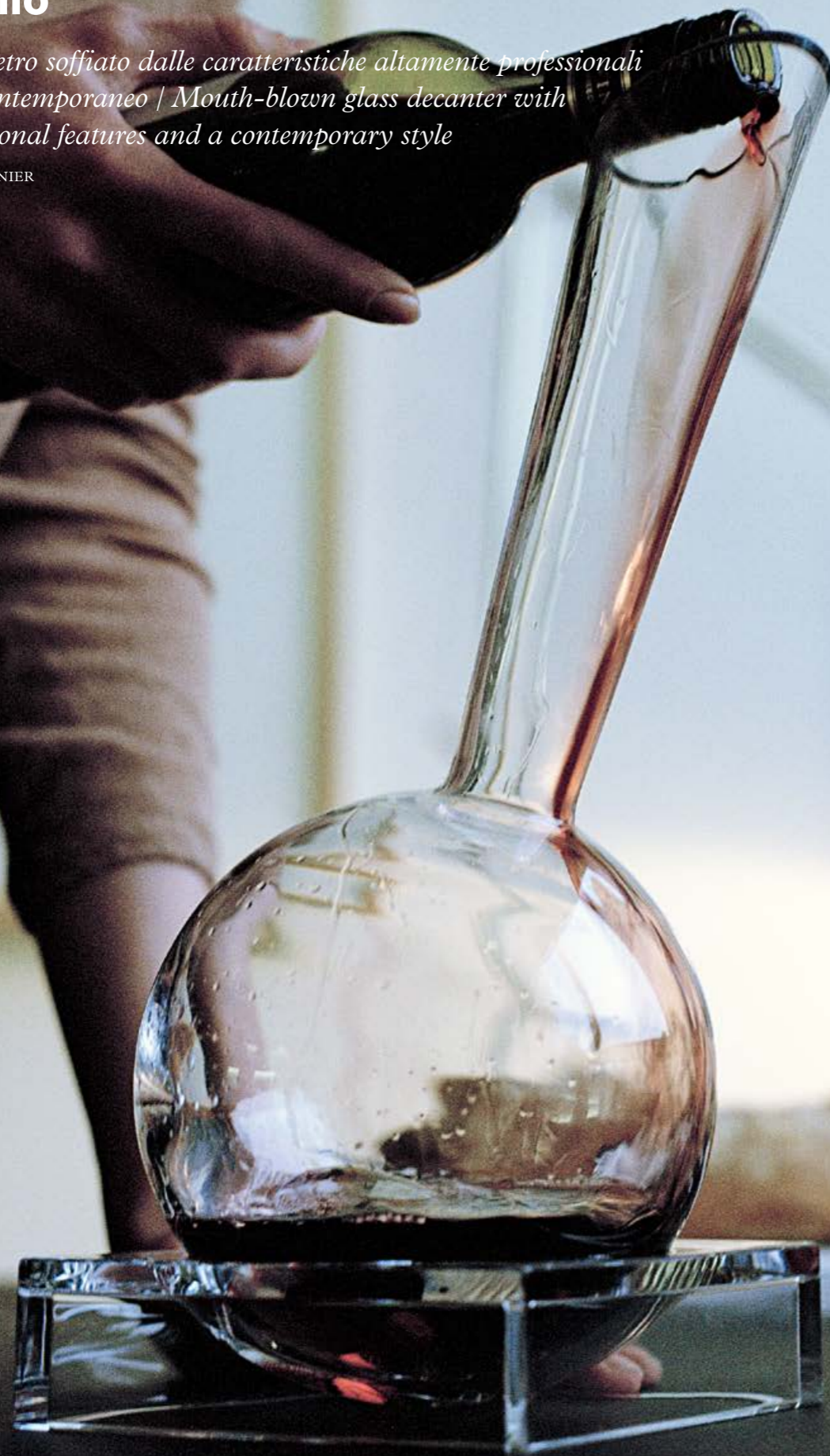

**IT** Vinocchio deve ironicamente il suo nome e le sue linee al naso e al volto di Pinocchio. Concepito per ossigenare i vini rossi, questo decanter in vetro soffiato è caratterizzato da uno stile vivace e innovativo in tutti i dettagli: imboccatura con taglio obliquo, impugnatura ergonomica, bilanciamento ottimale, piquère profonda, base in materiale acrilico.

**EN** Vinocchio is a play on the name and shape of Pinocchio's nose and face. Designed to oxygenate red wines, this blown glass decanter is characterized by a brilliant and innovative style in all details: slanted mouth, ergonomic handling, excellent balance, deep piquère and acrylic base.

VINOCCHIO

art. 1335

MATERIALE / MATERIAL  
**Vetro soffiato a bocca, lavorato a mano** / decanter e **acrilico base** /  
**Mouth-blown hand-crafted glass** / decanter and **acrylic base**

CAPACITÀ / CAPACITY  
**1500 cc / 50 ¾ oz**

COLORI / COLOURS  
**Clear**

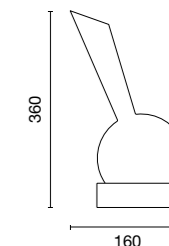

# Alavin

*Alavin è l'unico decanter al mondo capace di ossigenare i vini rossi e bianchi mantenendo la temperatura ottimale. | Alavin is the only decanter in the world that can oxygenate red and white wines while keeping the optimum temperature*

design by FEDERICO VENIER



**IT** Caratterizzato da una base basculante portagiaccio, Alavin è un decanter professionale unico nel suo genere in quanto caratterizzato da forme e funzioni, come quella “refrigeratrice”, studiate per decantare vini rossi invecchiati mantenendo la corretta temperatura. Alavin è naturalmente perfetto anche per servire vini bianchi complessi unendo la funzionalità propria del decanter a quella del bucket. Alavin è dotato di un tappo in acrilico trasparente che permette il servizio anche nei banchetti all'aperto.

**EN** Equipped with a tilting base that can be filled with ice, Alavin is a professional decanter, the only one of its kind, as it is characterized by shapes and functions, such as the ‘refrigerator’ one, especially studied to decanter red wines while maintaining the correct temperature. Alavin is also perfect for serving white complex wines as it combines the decanter function with that of an ice bucket. In addition, Alavin is equipped with an acrylic stopper which makes it suitable to be used in outdoor settings as well.

## SET ALAVIN

art. 1345

MATERIALE / MATERIAL  
**Vetro soffiato a bocca,**  
**lavorato a mano** decanter  
**e acrilico-silicone** base /  
**Mouth-blown hand-crafted**  
**glass** decanter  
**and acrylic-silicone** base

CAPACITÀ / CAPACITY  
**1700 cc / 57 ½ oz**

COLORI / COLOURS  
**Clear**

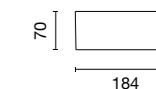
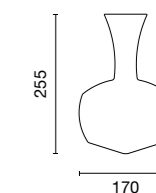



## Vertigo Decanter

*Il design a spirale si unisce alla ricercatezza del vetro soffiato a bocca e lavorato a mano nel nuovo Vertigo Decanter / The spiraling design meets the sophistication of mouth-blown and handcrafted glass in Vertigo Decanter*

design by ITALESSE



**IT** Vertigo Decanter è ideato per l'ossigenazione ottimale del vino, che può essere così esaltato e servito a tavola con finezza e vivacità. Un decanter ideale per servire il vino rosso, anche utilizzabile come caraffa per l'acqua e ogni genere di bevanda, essendo dotato di un tappo che ne permette l'utilizzo ai banchetti all'aperto.

**EN** Vertigo Decanter is ideal for optimal oxygenation of wine, elevating the taste and serving the wine at table with liveliness and delicacy. This decanter is perfect for serving red wine, but it is also usable as a carafe for water and any kind of beverage thanks to its stopper that allows the outdoor service.



**Acrylic Stopper**



VERTIGO DECANTER

**art. 1355**

MATERIALE / MATERIAL  
Vetro soffiato a bocca e lavorato a mano /  
Mouth-blown, hand-crafted glass

CAPACITÀ / CAPACITY  
1500 cc / 50 ¾ oz

COLORI / COLOURS  
Clear

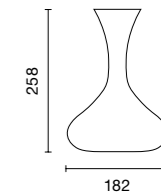

## Tonic Glass

*Bicchieri impilabili di vetro dalla linea conica, delicata quanto marcatamente definita, adatti in qualsiasi situazione / Conical Tonic Glass tumbler with a delicate and clearly defined design, an ideal choice in all situations*

design by CLAESSION KOIVISTO RUNE



**IT** L'eleganza e la semplicità rendono i bicchieri impilabili Tonic Glass adatti a qualsiasi situazione: una tavola raffinata, un aperitivo informale o proposto più semplicemente da solo. I Tonic Glass sono bicchieri impilabili multifunzionali, adatti a servire tutti i tipi di bevande, dall'acqua ai soft e long drink, dalla birra ai più elaborati cocktail. Tonic Glass Small è la versione piccola di Tonic Glass. Pensato per servire l'acqua in un bicchiere dalle dimensioni contenute, si distingue per fondi stonati e bevante sottile: bicchiere minimal ma di grande carattere. I dettagli tecnici ne fanno il bicchiere ideale per servire anche liquori e distillati e suggeriscono un nuovo modo di gustare il vino, decisamente più contemporaneo.

**EN** The elegance and simplicity of conical Tonic Glass make it the ideal choice for all situations: a refined table, an informal aperitif or presented alone in all its deliberate simplicity. Stackable and multifunctional, Tonic Glass is ideal for serving all types of drinks, ranging from water to soft and long drinks, beer and elaborate cocktails. Tonic Glass Small is the small version of Tonic Glass. Designed to serve water in a glass of a smaller size, it is characterized by a rounded base and a delicate rim making it minimal yet full of character. The technical details make it the ideal glass for serving liqueurs and spirits, as well as a contemporary and suggestive way to enjoy wine.

TONIC GLASS

art. 3318

MATERIALE / MATERIAL  
Vetro / Glass

CAPACITÀ / CAPACITY  
400 cc / 13 ½ oz

COLORI / COLOURS  
Clear

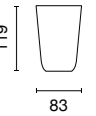

TONIC GLASS SMALL

art. 3317

MATERIALE / MATERIAL  
Vetro / Glass

CAPACITÀ / CAPACITY  
290 cc / 9 ¾ oz

COLORI / COLOURS  
Clear



## Kodama Tumbler

*Tumbler dalle linee eleganti e potenti |Elegant shapes  
for a tumbler of great visual impact*

design by ITALESSE



**IT** Ispirato alle forme dei tronchi degli alberi, il Kodama Tumbler è un bicchiere dal design elegante e innovativo, realizzato per l'intenso uso quotidiano. Perfetto per gustare cocktail, succhi di frutta e acqua.

**EN** Kodama Tumbler, inspired by the trunks of trees, is a tumbler featuring an innovative and elegant design, made for an intense daily use. Perfect for serving cocktails, fruit juices, and water.

KODAMA TUMBLER

art. 3379

MATERIALE / MATERIAL

Vetro / Glass

CAPACITÀ / CAPACITY

400 cc / 13 ½ oz

COLORI / COLOURS

Clear

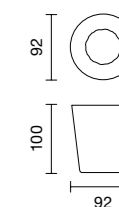

## Go Go

*Bicchieri da liquore e distillati caratterizzati da coppe ampie che amplificano le potenzialità degustative, disponibili in due varianti | Liqueur and spirits glasses characterized by wide bowls that heighten the tasting experience, available in two variations*

design by ITALESSE

**IT** La sinuosità delle linee di Go-Go, tumbler dalle proporzioni e dalla capacità generosa, ritrova gli stessi equilibri anche nella versione small. Capaci di esaltare i profumi del distillato e di far percepire profondamente gli aromi grazie all'ampia coppa che ne amplifica e sprigiona le potenzialità degustative. Nati per degustare anche liquori dolci, limoncelli e amari, entrambi i calici presentano una capacità di 4 cl nella base.

**EN** The sinuosity of Go-Go, a large-sized tumbler, is also balanced in its small version. Capable to enhance the flavor of distillates and to help aromas be fully perceived thanks to its large cup, which amplifies and enhances tastes. The capacity of the base of both glasses, which have been designed to also taste sweet liquors, limoncello and bitters, is 4 cl.

GO-GO

art. 3319

MATERIALE / MATERIAL  
Vetro cristallino soffiato in automatico  
in assenza di piombo / Crystalline  
automatic blown glass with no lead

CAPACITÀ / CAPACITY  
580 cc / 19 3/4 oz

COLORI / COLOURS  
Clear

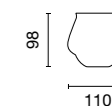

GO-GO SMALL

art. 3328

MATERIALE / MATERIAL  
Vetro cristallino soffiato in automatico  
in assenza di piombo / Crystalline  
automatic blown glass with no lead

CAPACITÀ / CAPACITY  
320 cc / 320 3/4 oz

COLORI / COLOURS  
Clear

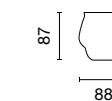

# Premium Collection

*Bicchieri polifunzionali in vetro cristallino perfetti per il mondo mixology | Multifunctional glasses made of crystalline glass, perfect for the world of mixology world*

design by ITALESSE

**IT** La linea premium di Italesse è specificamente studiata per soddisfare tutte le esigenze di servizio legate al mondo mixology: long e soft drinks, cocktails, whisky, martini etc. e diventano l'assortimento perfetto per i contesti bar e ristorante. Profili morbidi e trasparenza di luce grazie al materiale vetro cristallino per una linea sobria e raffinata formata da due tumbler bassi, due tumbler allungati, una coppa martini e un mini tumbler shot. Questi prodotti sono attentamente studiati nelle capacità e altamente polifunzionali. Dotati di un fondo spesso che garantisce la massima resistenza ed eleganza.

**EN** Italesse premium line is specifically designed to meet all service requirements linked to the mixology world: long and soft drinks, cocktails, whiskeys, martinis. They are the perfect range for bars / restaurants. Soft shapes and brilliance thanks to the crystal-clear glass for a sober and refined line consisting of two low tumblers, two tall tumblers, a martini glass and a mini tumbler shot. The capacity of these items is carefully studied and multifunctional. They come with a thick base, which guarantees top resistance and elegance.



## PREMIUM MARTINI

art. 0034

MATERIALE / MATERIAL  
Vetro cristallino soffiato in automatico  
in assenza di piombo / Crystalline  
automatic blown glass with no lead

CAPACITÀ / CAPACITY  
240 cc / 8 oz

COLORI / COLOURS  
Clear

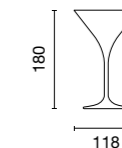

## PREMIUM TUMBLER LARGE

art. 0030

MATERIALE / MATERIAL  
Vetro cristallino soffiato in automatico  
in assenza di piombo / Crystalline  
automatic blown glass with no lead

CAPACITÀ / CAPACITY  
465 cc / 15 3/4 oz

COLORI / COLOURS  
Clear

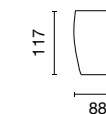

## PREMIUM TUMBLER

art. 0025

MATERIALE / MATERIAL  
Vetro cristallino soffiato in automatico  
in assenza di piombo / Crystalline  
automatic blown glass with no lead

CAPACITÀ / CAPACITY  
345 cc / 11 3/4 oz

COLORI / COLOURS  
Clear

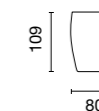

## PREMIUM HI-BALL LARGE

art. 0033

MATERIALE / MATERIAL  
Vetro cristallino soffiato in automatico  
in assenza di piombo / Crystalline  
automatic blown glass with no lead

CAPACITÀ / CAPACITY  
435 cc / 14 3/4 oz

COLORI / COLOURS  
Clear

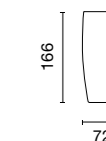

## PREMIUM HI-BALL

art. 0032

MATERIALE / MATERIAL  
Vetro cristallino soffiato in automatico  
in assenza di piombo / Crystalline  
automatic blown glass with no lead

CAPACITÀ / CAPACITY  
310 cc / 10 1/2 oz

COLORI / COLOURS  
Clear

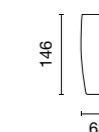

## PREMIUM SHOT

art. 0031

MATERIALE / MATERIAL  
Vetro cristallino soffiato in automatico  
in assenza di piombo / Crystalline  
automatic blown glass with no lead

CAPACITÀ / CAPACITY  
72 cc / 2 1/2 oz

COLORI / COLOURS  
Clear

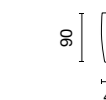

## Beach Collection

*Una proposta di calici e bicchieri perfetti in ambienti outdoor per un servizio glamour in piena sicurezza | A collection of stemware and tumblers perfect for outdoor environments, for glamorous service in complete safety*

design by ITALESSE



**IT** Funzionale, infrangibile, divertente, la linea Beach ripropone i calici, le flûte, i tumbler Italesse in versione outdoor, pratici e sicuri perché assolutamente indistruttibili. Perfetti per il mondo outdoor (piscine, spiagge, club), la linea è realizzata in materiali plastici nobili declinati in un'ampia gamma di prodotti, dal tumbler per acqua e soft drink, al calice per vini bianchi e rossi, dal flûte da champagne alla più glamour coppa martini.



**EN** Functional, unbreakable, fun, the Beach line proposes Italesse stem glasses, flutes, tumblers in their practical and safe thanks to their unbreakable qualities. Perfect for outdoor settings (pools, spas, beaches, clubs), the line is made of premium quality plastic materials for a wide range of products, from the tumbler for water and soft drinks, the stem glass for red and white wines to the champagne flute and the glamorous Martini glass.



## MARTINI BEACH

art. 3945

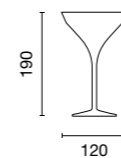
MATERIALE / MATERIAL  
**Policrystal®**CAPACITÀ / CAPACITY  
**270 cc / 9 oz**COLORI / COLOURS  
**Clear**

## VERTICAL BEACH

art. 3930

MATERIALE / MATERIAL  
**Policrystal®**CAPACITÀ / CAPACITY  
**330 cc / 11 oz**COLORI / COLOURS  
**Clear**

## PRIVÉ BEACH

art. 3920

MATERIALE / MATERIAL  
**SAN / Policrystal®**CAPACITÀ / CAPACITY  
**130 cc / 4 1/4 oz**COLORI / COLOURS  
**Clear White**

## BREW BEACH 40

art. 3917

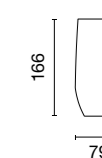
MATERIALE / MATERIAL  
**Policrystal®**CAPACITÀ / CAPACITY  
**500 cc / 17 oz**COLORI / COLOURS  
**Clear**

## BREW BEACH 33

art. 3916

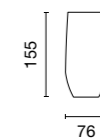
MATERIALE / MATERIAL  
**Policrystal®**CAPACITÀ / CAPACITY  
**450 cc / 15 1/4 oz**COLORI / COLOURS  
**Clear**

## VERTICAL PARTY BEACH

art. 3935

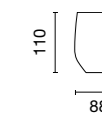
MATERIALE / MATERIAL  
**Policrystal®**CAPACITÀ / CAPACITY  
**420 cc / 14 1/4 oz**COLORI / COLOURS  
**Clear White Blue**



## Kodama Beach Tumbler

*Tumbler eleganti, innovativi e green /*

*Elegant, innovative and eco-friendly tumblers*

design by ITALESSE



**IT** Ispirati alle forme dei tronchi degli alberi, i Kodama Beach sono dei bicchieri dal design elegante e innovativo, perfetti per gustare cocktail, succhi di frutta e acqua in ambienti outdoor. Grazie alla realizzazione in EcoRec® un composto di materiali plastici riciclati e fibre naturali, con ridotte emissioni di CO<sub>2</sub>, i Kodama Tumbler sono prodotti ecosostenibili e riciclabili nella normale filiera della plastica.

**EN** Kodama Beach, inspired by the trunks of trees, are tumblers featuring an innovative and elegant design, perfect for serving cocktails, fruit juices, and water in outdoor settings. The realization in EcoRec®, a compound made of recycled plastic materials and natural fibers, produced with reduced CO<sub>2</sub> emissions, makes Kodama Beach environmentally sustainable and completely recyclable in the plastic bin.



## KODAMA BEACH TUMBLER LARGE

art. 3942

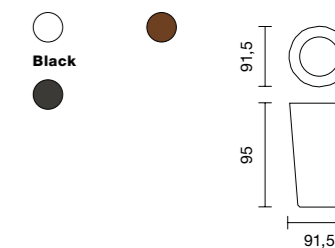
MATERIALE / MATERIAL  
EcoRec®CAPACITÀ / CAPACITY  
500 cc / 17 ozCOLORI / COLOURS  
Light Dark

## KODAMA BEACH TUMBLER SMALL

art. 3943

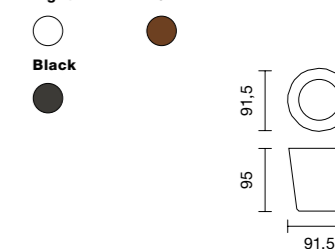
MATERIALE / MATERIAL  
EcoRec®CAPACITÀ / CAPACITY  
400 cc / 13 ½ ozCOLORI / COLOURS  
Light Dark

## Moonlight & Sunlight Collection

*Calici ideali per servire vini e aperitivi in ambienti outdoor, da oggi disponibili anche in EcoMat® | Stem glasses ideal for tasting wine and aperitifs outdoor, now available also in EcoMat®*

design by ITALESSE

**IT** Grazie all'attività di ricerca svolta negli ultimi anni e agli interventi innovativi compiuti in fase di produzione, Italesse è lieta presentare Moonlight e Sunlight non solo in materiale plastico ma anche in versione EcoMat®, un composto di materie prime provenienti da fonti rinnovabili, biodegradabili e realizzati con ridotte emissioni di CO2. Moonlight e Sunlight sono da oggi calici capaci quindi di coniugare una funzionalità straordinaria, pensata per le attività all'aperto, feste e catering, con linee moderne ed eleganti e anche con il rispetto dell'ambiente.

**EN** Thanks to the research carried out in recent years and the innovative interventions made in the production phase, Italesse is pleased to present Moonlight and Sunlight, not only in plastic material but also in the EcoMat® version, which is a compound of raw materials made from renewable sources, biodegradable and made with reduced CO2 emissions. Moonlight and Sunlight wine glasses are now capable of combining extraordinary functionality, designed for outdoor activities, parties and catering, with modern and elegant lines while also respecting the environment.



### MOONLIGHT BEACH

art. 3931

MATERIALE / MATERIAL  
**SAN / Policrystal® / Eco Rec® \***

CAPACITÀ / CAPACITY  
**410 cc / 13 3/4 oz**

COLORI / COLOURS  
**Clear White**



**Integrale \***



### SUNLIGHT BEACH

art. 3922

MATERIALE / MATERIAL  
**SAN / Policrystal® / Eco Rec® \***

CAPACITÀ / CAPACITY  
**330 cc / 11 1/4 oz**

COLORI / COLOURS  
**Clear White**



**Integrale \***



## Bolle Beach Tumbler

*Un bicchiere in policarbonato con una superficie ricca di bolle in rilievo, Bolle Beach Tumbler dona un tocco vivace e divertente alla collezione | A polycarbonate glass with a surface with embossed bubbles Bolle Beach Tumbler gives the collection a fun and lively touch*

design by LUCA TRAZZI



**IT** Un design emozionale ed originale caratterizza questo bicchiere. Adatto a servire acqua, freschi succhi di frutta o aperitivi alcolici, Bolle Beach Tumbler è ideale per essere utilizzato in ambienti professionali in quanto funzionale, impilabile e resistente nel servizio e si inserisce perfettamente anche in moderni ambienti casa sia indoor che outdoor.



**EN** An original and emotional design characterizes this tumbler. Suitable for serving water, fresh fruit juices or alcohol-based drinks, Bolle Beach Tumbler is ideal in professional environments for its functionality, stackability and durability yet lends itself perfectly to use in the modern home, both indoors and outdoors.

BOLLE BEACH TUMBLER

art. 3941

MATERIALE / MATERIAL  
**Polycrystal®**

CAPACITÀ / CAPACITY  
**350 cc / 11 ¾ oz**

COLORI / COLOURS  
**Clear**

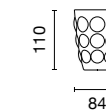

## Air Beach Collection

*Calici realizzati in materiale plastico Tritan™, ideali per servire vini e aperitivi in ambienti outdoor | Plastic glasses made in Tritan™ ideal for tasting wine and aperitifs outdoor*

design by ITALESSE

**IT** Linea di calici e bicchieri in materiale plastico Tritan™, dalle forme pure e classiche composta, tra gli altri, dall'iconico modello Air Beach G&T. Collezione estremamente versatile, indicata per il servizio professionale. La tecnica di soffiatura permette una fedele emulazione delle forme tradizionali dei calici in vetro. Gli spessori sono meno importanti, il che li rende leggerissimi e maneggevoli al tatto. Gli Air Beach sono ideali per una degustazione o grande manifestazione outdoor, per i locali sulle spiagge e con spazi all'aperto, gli hotel con servizio bar in piscina o in spiaggia. Tutti momenti e luoghi dove l'impiego del vetro può risultare poco sicuro.

**EN** A line of stemware and tumblers realized in plastic material Tritan™, with pure and classic shapes and comprising, among others, the iconic Air Beach G&T. This collection is extremely versatile, recommended for professional services. The blowing technique allows for a perfect emulation of the traditional shapes of glass stemware. Given the reduced thickness, they are extremely light and easy to handle. The Air Beach collection is ideal for tastings and events that take place outside, for venues on the beach or other outdoor settings, for hotels who comprise services on the beach or in the pool. All situations in which the use of glass stemware could represent a risk.



### AIR BEACH G&T

art. 0048

MATERIALE / MATERIAL  
Tritan™ soffiato in automatico /  
Automatic blown Tritan™

CAPACITÀ / CAPACITY  
700 cc / 23 ¾ oz

COLORI / COLOURS  
Clear

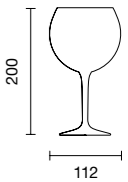

### AIR BEACH WINE

art. 0050

MATERIALE / MATERIAL  
Tritan™ soffiato in automatico /  
Automatic blown Tritan™

CAPACITÀ / CAPACITY  
475 cc / 16 oz

COLORI / COLOURS  
Clear White

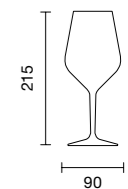

### AIR BEACH FLÛTE 20

art. 0063

MATERIALE / MATERIAL  
Tritan™ soffiato in automatico /  
Automatic blown Tritan™

CAPACITÀ / CAPACITY  
200 cc / 6 ¾ oz

COLORI / COLOURS  
Clear

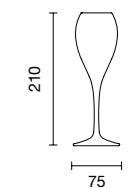



## AIR BEACH TUMBLER 42

art. 0069

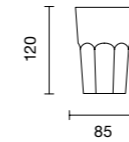
MATERIALE / MATERIAL  
**SAN**CAPACITÀ / CAPACITY  
**425 cc / 14 ¼ oz**COLORI / COLOURS  
**Clear**

## AIR BEACH TUMBLER 29

art. 0068

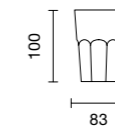
MATERIALE / MATERIAL  
**SAN**CAPACITÀ / CAPACITY  
**290 cc / 9 ¾ oz**COLORI / COLOURS  
**Clear**

## AIR BEACH SHOT

art. 0070

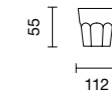
MATERIALE / MATERIAL  
**SAN**CAPACITÀ / CAPACITY  
**40 cc / 1 ¼ oz**COLORI / COLOURS  
**Clear**

## AIR BEACH PARTY

art. 0071

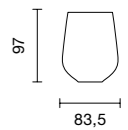
MATERIALE / MATERIAL  
**Tritan™ soffiato in automatico /**  
**Automatic blown Tritan™**CAPACITÀ / CAPACITY  
**390 cc / 13 oz**COLORI / COLOURS  
**Clear**

## AIR BEACH COCKTAIL

art. 0072

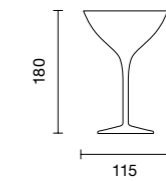
MATERIALE / MATERIAL  
**Tritan™ soffiato in automatico /**  
**Automatic blown Tritan™**CAPACITÀ / CAPACITY  
**300 cc / 10 oz**COLORI / COLOURS  
**Clear**

## AIR BEACH KRAFT BEER

art. 0073

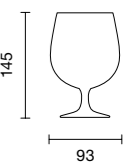
MATERIALE / MATERIAL  
**Tritan™ soffiato in automatico /**  
**Automatic blown Tritan™**CAPACITÀ / CAPACITY  
**516 cc / 17 ½ oz**COLORI / COLOURS  
**Clear**

# Fresnel Collection

*Prende il nome dall'omonima lente la linea di calici  
Fresnel Beach, ispirata alle tradizionali coppe muranesi /  
Fresnel Beach, the line of glasses that draws inspiration  
for traditional Murano glasses*

design by LUCA NICHETTO



**IT** Realizzata in materiale plastico resistente quanto duttile, Fresnel presenta una decorazione tridimensionale della superficie che garantisce la resistenza ai graffi e ne amplifica i riflessi. Accattivante sul piano estetico, leggera e antigraffio, la nuova linea composta da un calice vino, un flûte da champagne e un tumbler, per i ristoranti e club più glamour, proponendo un nuovo stile per serate all'insegna di meravigliosi giochi di luce.

**EN** Made of resistant and supple plastic, Fresnel features a three-dimensional surface decoration for enhanced reflections and guarantees scratch-proof properties. The Fresnel line is charming, lightweight, non-scratch and consists of a wine glass, a champagne flûte and a tumbler. The line gives a new edge to glamorous restaurants and clubs proposing a new style for nights with wonderful plays of light.



## FRESNEL WINE

**art. 3946**

MATERIALE / MATERIAL  
**Policrystal®**

CAPACITÀ / CAPACITY  
**330 cc / 11 oz**

COLORI / COLOURS  
**Clear**



## FRESNEL FLÛTE

**art. 3947**

MATERIALE / MATERIAL  
**Policrystal®**

CAPACITÀ / CAPACITY  
**200 cc / 6 3/4 oz**

COLORI / COLOURS  
**Clear**



## FRESNEL PARTY

**art. 3948**

MATERIALE / MATERIAL  
**Policrystal®**

CAPACITÀ / CAPACITY  
**360 cc / 12 oz**

COLORI / COLOURS  
**Clear**

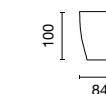

## Tonic Beach

*Bicchieri in policarbonato impilabili, disponibili in due capacità e perfetti per servire qualsiasi tipo di bibita | Stackable polycarbonate glasses, available in two different capacities that are ideal for serving all kinds of drinks*

design by CLAESSION KOIVISTO RUNE

**IT** Tonic beach, realizzato in Policrystal® infrangibile e lavabile in lavastoviglie, è stato pensato per servire long e soft drinks, come ogni tipo di bibita, dalla birra all'acqua. La forma conica lo rende perfettamente impilabile e dunque funzionale per l'ottimizzazione degli spazi in ambienti bar/club. Disponibile in due dimensioni (350 cc e 500 cc).

**EN** Tonic beach, made of unbreakable, dishwasher safe, Policrystal® material, has been designed to serve long and soft drinks, and all types of drinks, from beer to water. Thanks to its conical shape, it is perfectly stackable, therefore functional for space optimization in bars/clubs. It comes in two sizes (350 cc and 500 cc).



### TONIC BEACH LARGE

art. 3903

MATERIALE / MATERIAL  
**Policrystal®**

CAPACITÀ / CAPACITY  
**500 cc / 16 ¾ oz**

COLORI / COLOURS  
**White Frost**



### TONIC BEACH MEDIUM

art. 3902

MATERIALE / MATERIAL  
**Policrystal®**

CAPACITÀ / CAPACITY  
**350 cc / 11 ¾ oz**

COLORI / COLOURS  
**White Frost**

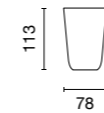

## Pachà Beach Light

*Bicchieri in polipropilene opalescente dalle caratteristiche ottimali per la preparazione di pestati e cocktail | Tumblers in opalescent polypropylene with optimum characteristics for the preparation of drinks made with crushed ice and cocktails*

design by ITALESSE

**IT** Tumbler in polipropilene opalescente infrangibile disponibile nelle due varianti Large e Medium. Fondo spesso e diametro della bocca studiato per interagire con lo shaker rendono questo bicchiere ideale per la preparazione di pestati e cocktail di ogni genere. Bestseller nei club di tutto il mondo per estetica e praticità.

**EN** Unbreakable, opalescent polypropylene tumbler available in two variants, Large and Medium. The thick bottom and the mouth diameter designed to fit the shaker make this glass the ideal solution to prepare all kinds of mashed cocktails and cocktails. Because of its look and convenience, it is a bestseller item in clubs all over the world.



### PACHÀ BEACH LIGHT LARGE

art. 3901

MATERIALE / MATERIAL  
**Polipropilene / Polypropylene**

CAPACITÀ / CAPACITY  
**500 cc / 16 ¾ oz**

COLORI / COLOURS  
**White Frost**

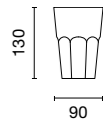

### PACHÀ BEACH LIGHT MEDIUM

art. 3900

MATERIALE / MATERIAL  
**Polipropilene / Polypropylene**

CAPACITÀ / CAPACITY  
**400 cc / 13 ½ oz**

COLORI / COLOURS  
**White Frost**

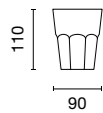



## Kodama Buckets & Bowl

*Kodama (木魂) è nella tradizione giapponese lo spirito che risiede negli alberi e che emana vitalità ed energia positiva. Un nome ed un auspicio che abbiamo voluto assegnare alla nostra nuova serie di vasche e secchielli ispirati alle forme dei tronchi degli alberi e realizzati in materiali riciclabili come l'EcoWood® e l'EcoMat® | Kodama (木魂) is the spirit in Japanese tradition that resides in trees and emanates vitality and positive energy. It is a name and wish that we wanted to assign to our new series of buckets and bowl inspired by the shapes of tree trunks and made of recycled materials like EcoWood® and EcoMat®*

design by SAMARITAN for ITALESSE



**IT** Prodotti in EcoRec®, composto da noi sviluppato, a base di materie prime provenienti da fonti rinnovabili, biodegradabili e realizzati con ridotte emissioni di CO2, Kodama Bucket, disponibile nella versione Small e da oggi anche Large, e Kodama Bowl sono prodotti professionali che riescono a coniugare perfettamente la funzionalità quotidiana proprio di questi oggetti sia con un design elegante e ricercato sia con il rispetto dell'ambiente. In particolare, Kodama Bucket Small è un secchiello dalle dimensioni ridotte, pensato per raffreddare una bottiglia di vino, spumante o champagne con il minimo ingombro della tavola mentre Kodama Bucket Large, avendo dimensioni più generose, può contenere una bottiglia di vino, spumante o champagne o una magnum. Kodama Bowl è invece una vasca con una presenza scenica unica, pensata per raffreddare fino a sei bottiglie di vino o cinque di spumante e champagne contemporaneamente.

**EN** Realized in EcoRec®, compounds developed by us, produced with raw materials derived from renewable and biodegradable sources and realized with reduced CO2 emissions. Kodama Bucket, now available in the Large format as well as the Small one, and Kodama Bowl are professional products that combine innovation, design, functionality and respect for the environment. Kodama Bucket Small, is a smaller bucket designed to cool one bottle of wine, sparkling wine or champagne, while Kodama Bucket Large, more generous in its size, can contain one bottle of wine, sparkling wine or champagne or a magnum. Kodama Bowl is designed to cool down up to six bottles of wine or five bottles of sparkling wine and/or champagne simultaneously.



## KODAMA BUCKET SMALL

art. 1594

MATERIALE / MATERIAL  
Eco Rec®COLORI / COLOURS  
Light

Dark



Black

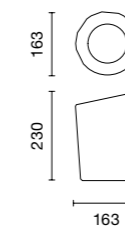

## KODAMA BUCKET LARGE

art. 1596

MATERIALE / MATERIAL  
Eco Rec®COLORI / COLOURS  
Light

Dark



Black

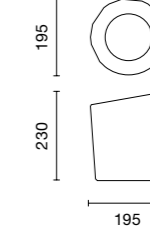

## KODAMA BOWL

art. 1619

MATERIALE / MATERIAL  
Eco Rec®COLORI / COLOURS  
Light

Dark



Black

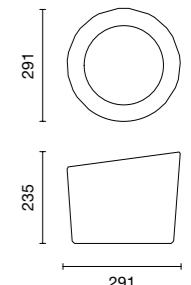

## Magnolia Bucket & Bowl

*Ispirata alle linee sinuose ed eleganti del fiore, Magnolia è una nuova serie di vasche e secchielli dalla grande presenza scenica, pensata per mettere in evidenza le bottiglie e allo stesso tempo adornare la tavola, anche grazie ai colori con cui questi prodotti possono essere realizzati | Inspired by the sinuous and elegant lines of the flower, Magnolia is a new series of bowls and buckets, designed in a way that best showcases the bottles and adorns the table, a choice aided also by the variety of colors available*

design by SAMARITAN for ITALESSE



**IT** Prodotti in EcoRec®, composto da noi sviluppato a base di materie prime provenienti da fonti rinnovabili, biodegradabili e realizzate con ridotte emissioni di CO<sub>2</sub>, queste vasche e secchielli professionali coniugano perfettamente la funzionalità quotidiana proprio di questi oggetti con un design ricercato, di grande presenza scenica, ed il rispetto dell'ambiente. In particolare, Magnolia Bucket è un secchiello pensato per raffreddare una bottiglia di vino e/o spumante e champagne mentre Magnolia Bowl è una vasca studiata per raffreddare fino a sei bottiglie.

**EN** Made in EcoRec® compound, developed by us, based on raw materials from renewable and biodegradable sources as well as reduced CO<sub>2</sub> emissions, these professional buckets and bowls combine innovation, design, functionality and respect for the environment. The collection consists of Magnolia Bucket, designed to cool a bottle of wine and/or sparkling wine and champagne, and Magnolia Bowl, designed to cool up to six bottles of wine and/or sparkling wine and champagne.



#### MAGNOLIA BUCKET

art. 1595

MATERIALE / MATERIAL  
Eco Rec®

COLORI / COLOURS  
Light



Dark



Black

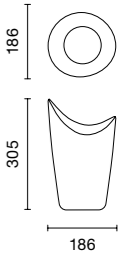

#### MAGNOLIA BOWL

art. 1621

MATERIALE / MATERIAL  
Eco Rec®

COLORI / COLOURS  
Light



Dark



Black

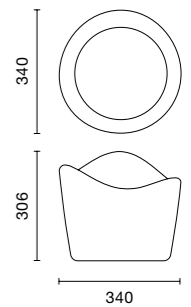

# Timber Bucket & Bowl

*La collezione abbina un design elegante, linee minimal e sofisticate con materiali innovativi, creando un prodotto ecologico e personalizzabile | Timber Collection combines an elegant design, minimal and sophisticated lines with innovative materials, creating an innovative, organic and customizable product*

design by ITALESSE



**IT** La collezione Timber Bucket & Bowl abbina un design elegante e linee minimal e sofisticate ad un materiale innovativo come l'EcoWood® e l'EcoRec®, un composti da noi sviluppati, di derivazione naturale, biodegradabile e realizzato con ridotte emissioni di CO2. Grazie alle sue caratteristiche, questa collezione è stata premiata, a fine 2018, con il BarAward® “Innovazione dell’Anno”. Timber, ispirato al mondo degli alberi e alle doghe del legno usato per le barriques, ha infinite possibilità di personalizzazione e diverse essenze di colore. Il cliente può richiedere una particolare tonalità del legno, colorare l’interno e decidere come applicare il proprio logo: marchio a fuoco, targa in alluminio, stampa.

**EN** The Timber Bucket & Bowl combine elegant design and minimal and sophisticated lines with EcoWood® and l'EcoRec®, innovative compounds developed by us, made from organic materials and renewable and biodegradable sources as well as reduced CO2 emissions. Thanks to its characteristics, this collection was awarded the BarAward® as “Innovation of the Year” 2018.

Timber, inspired by trees and the wood used for the barrels, has almost unlimited customization solutions.

The customer can ask for a particular essence, varnish the inside and decide how to apply their logo: iron branding, aluminum label, print.



## TIMBER BUCKET

art. 1592

MATERIALE / MATERIAL  
Eco Wood® / Eco Rec®

COLORI / COLOURS  
Naturale / Light



Esotico / Dark



Carbone / Black

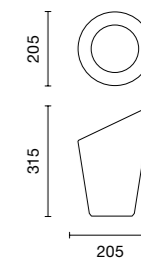

## TIMBER BOWL

art. 1618

MATERIALE / MATERIAL  
Eco Wood® / Eco Rec®

COLORI / COLOURS  
Naturale / Light



Esotico / Dark



Carbone / Black

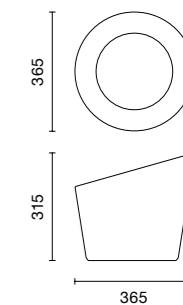

# Plaza Bucket & Bowl

*Un design all'avanguardia con una superficie sfaccettata che richiama il classico taglio del cristallo, il secchiello e la spumantiera Plaza catturano l'attenzione con un brillante gioco di luci | A pioneering design with a textured surface that evokes the traditional cut of crystals, the Plaza Bucket and Bowl draw your attention with their brilliant plays of light*

design by LUCA TRAZZI



**IT** Il secchiello e la spumantiera Plaza sono estremamente luminosi grazie alla loro realizzazione in materiali acrilici di qualità cristallina. L'effetto scintillante è accentuato dall'aggiunta di una base LED ricaricabile opzionale che illumina il ghiaccio e le bottiglie contenute. Plaza è perfettamente impilabile.

**EN** The Plaza Bucket and Bowl are extremely luminous and are made with crystalline quality acrylic materials. The scintillating effect is heightened with the addition of an optional, rechargeable LED base which illuminates the ice and the bottles it contains. Plaza is fully stackable.



Disponibile con base LED /  
Available with LED base

## PLAZA BUCKET

art. 1584

MATERIALE / MATERIAL  
Acrilico / Acrylic

COLORI / COLOURS  
Clear

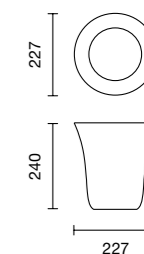

## PLAZA BOWL

art. 1616

MATERIALE / MATERIAL  
Acrilico / Acrylic

COLORI / COLOURS  
Clear

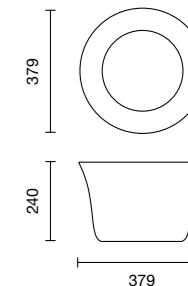

## Bolle Bucket & Bowl

*Vere icone della collezione Italesse, il secchiello e la spumantiera Bolle sono interamente ricoperte da sfere di materiale acrilico trasparente, che le rendono luminose ed eleganti | Icons in Italesse's collection, Bolle Bucket and Bowl are completely covered with clear acrylic spheres, which make them extremely bright and elegant*

design by LUCA TRAZZI



**IT** Esaltata dai tanti e continui giochi di luce, la collezione Bolle si caratterizza per la leggerezza della luminosità, il suo stile e la sua raffinatezza. Adatta ad ambienti indoor e outdoor e a ogni tipo di tavola.

**EN** Enhanced by uninterrupted plays of light, the Bolle collection is characterized by its style, luminosity and elegance, which makes it suitable for indoor and outdoor environments and all types of tables.



## BOLLE BUCKET

art. 1586  
art. 1587 - Bolle Bucket Pro\*

MATERIALE / MATERIAL  
Acrilico / Acrylic

COLORI / COLOURS  
Clear

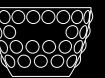
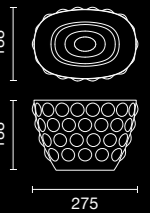

\*Bolle Bucket Pro  
personalizzabile /  
customizable

## BOLLE BOWL

art. 1612  
art. 1613 - Bolle Bowl Pro\*

MATERIALE / MATERIAL  
Acrilico / Acrylic

COLORI / COLOURS  
Clear

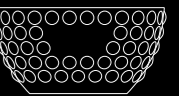
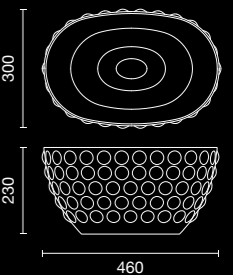

\*Bolle Bowl Pro  
personalizzabile /  
customizable



## Vela Buckets & Bowls

*Un secchiello ed una spumantiera dalla forma armonica e innovativa, esaltata ancor di più dalla base luminosa che mette in risalto la lucentezza dell'acrilico e le bottiglie in esso contenute / A bucket and a bowl with harmonious and innovative shapes. The led bases further enhance the beauty of these items and highlight the brilliance of the acrylic and the bottles they contain*

design by ITALESSE



**IT** Il secchiello e la spumantiera Vela posseggono un design curvo che richiama l'eleganza di una vela ed un bordo a taglio diamantato che valorizza la luminosità e gli spessori. Realizzati in materiale ad alta trasparenza, i Vela di Italesse possono essere illuminati grazie a una base LED ricaricabili ed utilizzati come supporto espositivo. La forma innovativa, con la schiena a ventaglio, attira l'attenzione ed esalta il valore delle bottiglie in essi contenute, l'ergonomia li rende semplici da utilizzare.

**EN** Designed with elegant curves the Vela Bucket and Bowl echo the shapes of a wind-filled sail, a diamond-cut edge heightens the luminosity of these containers. Manufactured in highly transparent material, the Vela products can be illuminated with a rechargeable LED base that allows for a better display of the bottles. Their unique shape with their fan-shaped back capture the onlooker's attention and serve to highlight the value of the bottles contained as well as giving them a highly ergonomic design.



Disponibile con base LED /  
Available with LED base

## VELA BUCKET

art. 1583

MATERIALE / MATERIAL  
Acrilico / AcrylicCOLORI / COLOURS  
Clear

White



271

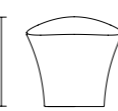

207

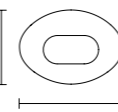

288

## VELA BOWL

art. 1615

MATERIALE / MATERIAL  
Acrilico / AcrylicCOLORI / COLOURS  
Clear

White



282



282

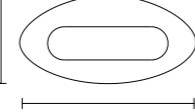

566

## VELA BUCKET ROUND

art. 1589

MATERIALE / MATERIAL  
Acrilico / AcrylicCOLORI / COLOURS  
Clear

White



Black



313,5



240



210

## VELA BOWL ROUND

art. 1617

MATERIALE / MATERIAL  
Acrilico / AcrylicCOLORI / COLOURS  
Clear

White



Black



313,5



360,5

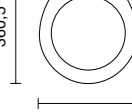

317,5

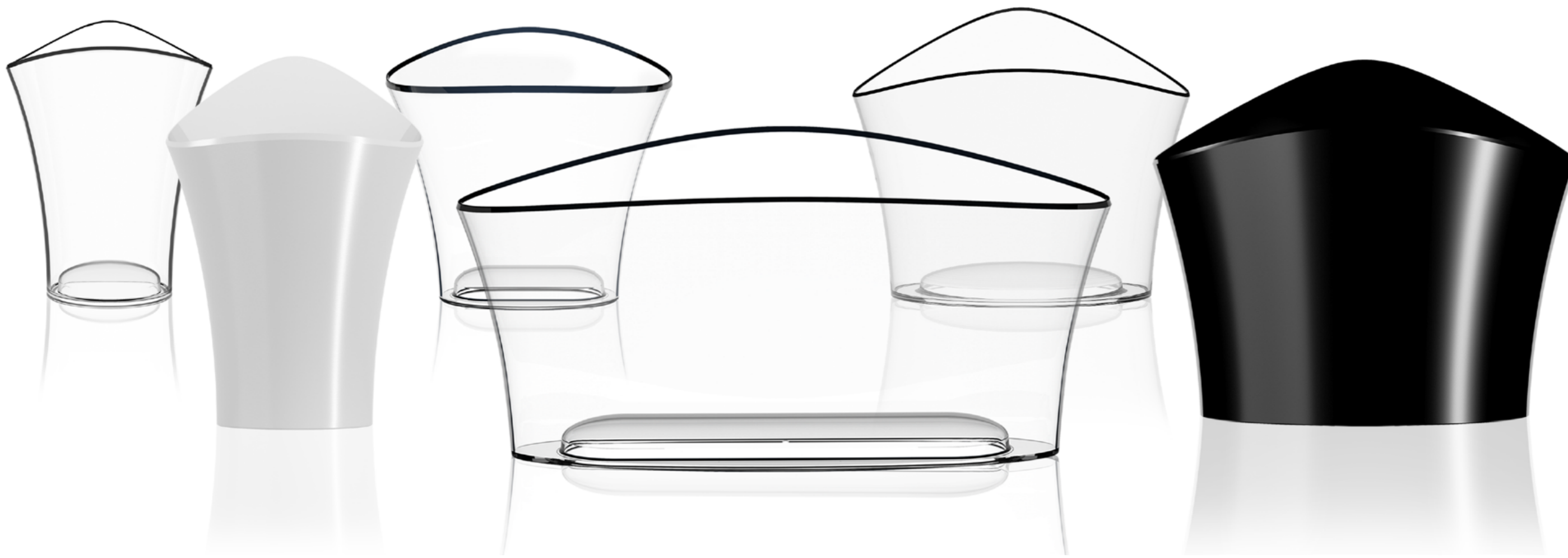

# Tonic Ice Bucket & Bowl

*Tonic Ice Bucket e Tonic Ice Bowl riprendono le linee coniche del bicchiere Tonic della collezione Italesse e reinventano lo stile di uno strumento ideale per il mondo della notte | Tonic Ice Bucket and Tonic Ice Bowl take the cone shaped lines of the Tonic glass of the Italesse collection and reinvent the style for the night world*

design by CLAESSON KOIVISTO RUNE



**IT** Un secchiello ed una spumantiera dalle linee semplici ma distintive. Dotati di una base luminosa interna, Tonic Ice Bucket & Bowl permettono di illuminare le bottiglie in essi contenute grazie all'estrema trasparenza del materiale acrilico di cui si compongono.

**EN** An ice bucket and Champagne bowl with simple, yet distinctive lines. An optional LED base illuminates the bottles they contain by virtue of the extreme transparency of the acrylic material of which the Bucket and Bowl are made.



**Disponibile con base LED / Available with LED base**

TONIC ICE BUCKET

**art. 1588**

MATERIALE / MATERIAL  
**Acrilico / Acrylic**

COLORI / COLOURS  
**Clear**

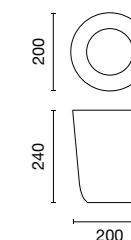

TONIC ICE BOWL

**art. 1614**

MATERIALE / MATERIAL  
**Acrilico / Acrylic**

COLORI / COLOURS  
**Clear**

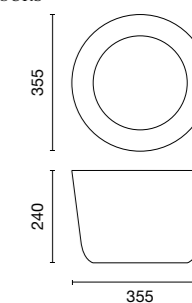

# Easy Buckets & Bowls

*Easy è la linea di secchielli e spumantiere dall'eleganza raffinata e formale | Easy is the refined, elegant and formal line of ice Buckets and Champagne Bowls*

design by FEDERICO VENIER

**IT** I secchielli e le spumantiere Easy sono caratterizzati da linee inclinate ed opposte del bordo superiore e del fondo. Questo particolare valorizza la bottiglia come se fosse posata su un supporto espositivo. Il loro bordo esterno a “taglio diamantato” ne valorizza la luminosità e gli spessori utilizzati. La spumantiera di questi modelli è studiata per cinque bottiglie di vino, quattro da Champagne, mentre il secchiello è ideale per una sola bottiglia per i modelli Square e Round e per due bottiglie per il modello Oval.

**EN** The collection of Easy Buckets and Bowls are characterized by slanted and opposed lines of the top edge and the base: this detail enhances the visibility of the bottle as if they were laid on a display support. Their top “diamond shaped cut” edge enhances their brightness and thickness. The Champagne Bowls of these models are designed to contain up to five wine bottles or four champagne bottles, while the Bucket is ideal for a single bottle in the Square and Round models and up to two bottles in the Oval model.

## EASY BUCKET OVAL

art. 1580

MATERIALE / MATERIAL  
Acrilico / Acrylic

COLORI / COLOURS  
Clear



White

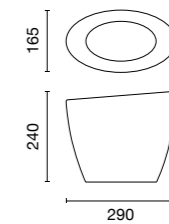

## EASY BOWL OVAL

art. 1609

MATERIALE / MATERIAL  
Acrilico / Acrylic

COLORI / COLOURS  
Clear



White

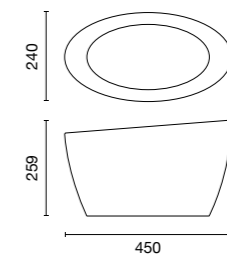

## EASY BUCKET SQUARE

art. 1578

MATERIALE / MATERIAL  
Acrilico / Acrylic

COLORI / COLOURS  
Clear



Black

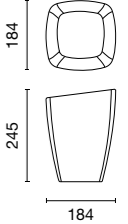

## EASY BOWL SQUARE

art. 1607

MATERIALE / MATERIAL  
Acrilico / Acrylic

COLORI / COLOURS  
Clear



Black

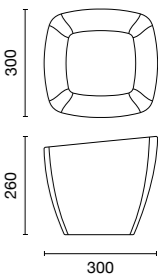

## EASY BUCKET ROUND

art. 1574

MATERIALE / MATERIAL  
Acrilico / Acrylic

COLORI / COLOURS  
Clear



Black

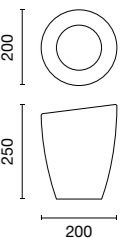

## EASY BOWL ROUND

art. 1605

MATERIALE / MATERIAL  
Acrilico / Acrylic

COLORI / COLOURS  
Clear



Black

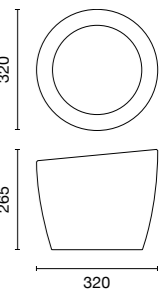

## Bongo Bucket & Bowl

*Caratterizzati da linee morbide e con una forma ellittica, il secchiello e la spumantiera Bongo sono oggetti dotati di una presenza forte e dal richiamo irresistibile al tavolo dei drink. Bongo Bucket e Bongo Bowl garantiscono una scorta di drink perfettamente ghiacciati per ogni occasione | With their soft lines and elliptical design the Bongo Bucket and Bongo Bowl, represent a captivating item for the drinks table. Bongo Bucket and Bowl provide perfectly cooled drinks for every occasion*

design by MINEDIVINE



**IT** Bongo Bowl può contenere nel ghiaccio fino a 5 bottiglie di vino e champagne o diverse bottiglie di piccolo formato. Bongo Bucket può ospitare una bottiglia anche inclinata. Ergonomico, di facile manutenzione e molto resistente, Bongo è realizzato in pregiato materiale acrilico altamente trasparente ed è ideale per bar, ristoranti e club.

**EN** Bongo Bowl can hold up to 5 champagne and wine bottles or several small bottles on ice. Bongo Bucket can also hold a tilted bottle. Ergonomic, easy to maintain and very strong, Bongo is made of premium, clear acrylic material and is an ideal solution for bars, restaurants and clubs.

### BONGO BUCKET

**art. 1562**

MATERIALE / MATERIAL  
**Acrilico / Acrylic**

COLORI / COLOURS  
**Clear**

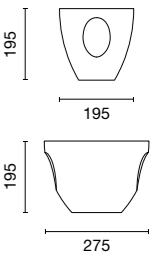

### BONGO BOWL

**art. 1630**

MATERIALE / MATERIAL  
**Acrilico / Acrylic**

COLORI / COLOURS  
**Clear**

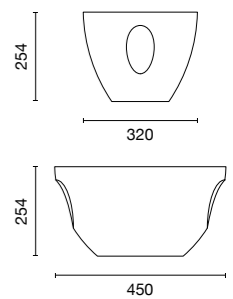

## Stainless Steel Collection

*Winston e Nevada sono linee di vasche e secchielli in acciaio inossidabile, perfette per raffreddare nel ghiaccio le bottiglie di ogni formato esaltandone la presentazione al bar ed a tavola | Winston and Nevada are the two stainless steel collections of buckets and bowls, perfect for refreshing bottles of wine of every size while displaying them on the table*

design by ITALESSE



**IT** Winston Bucket è un secchiello da Champagne in acciaio inox inossidabile. Elegante, resistente ed impilabile, Winston Bucket è ideale per raffreddare la bottiglia in esso contenuta ed accompagnare il servizio professionale con stile. Nella versione large, Winston Bucket Large è dotato di pomelli laterali e può contenere anche 2 bottiglie di vino. Winston Bowl è una vasca in acciaio inox inossidabile che coniuga eleganza e funzionalità divenendo l'oggetto perfetto per completare, con stile, il servizio professionale del vino. Elegante secchiello in acciaio inossidabile, Nevada Bucket è perfetto per raffreddare, con stile, bottiglie di vino e champagne. In acciaio inox inossidabile, Nevada Bowl è una vasca elegante, perfetta per esporre e mantenere fresche nel ghiaccio fino a 5 bottiglie di Champagne.

**EN** Winston Bucket is a stainless-steel Champagne bucket. Elegant, resistant and stackable, Winston Bucket is perfect for chilling the bottle it contains and it gives style to professional servings. In its larger version, Winston Bucket Large is equipped with pommels and can contain up to 2 bottles of wine. Winston Bowl is a stainless-steel Champagne bowl, which combines elegance and functionality becoming the perfect object to complete, with style, the professional wine service. An elegant stainless steel bucket, Nevada Bucket is perfect for cooling bottles of wine and champagne in style. Nevada Bowl is elegant and excellent for presenting and keeping fresh up to 5 bottles of Champagne.

## WINSTON BUCKET

art. 1707

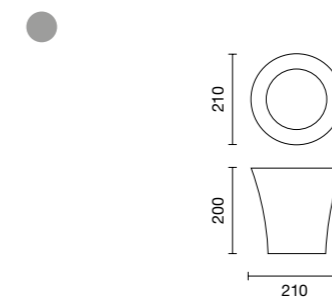
MATERIALE / MATERIAL  
Stainless steelCOLORI / COLOURS  
Inox

## WINSTON BUCKET LARGE

art. 1708

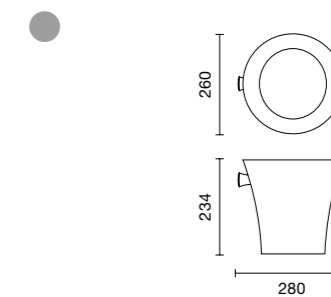
MATERIALE / MATERIAL  
Stainless steelCOLORI / COLOURS  
Inox

## WINSTON BOWL

art. 1706

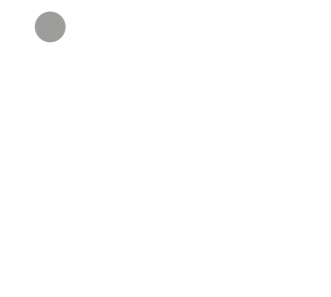
MATERIALE / MATERIAL  
Stainless steelCOLORI / COLOURS  
Inox

## NEVADA BUCKET

art. 1710

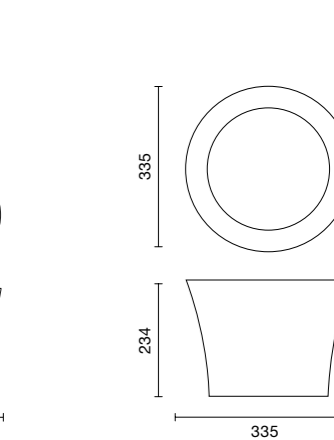
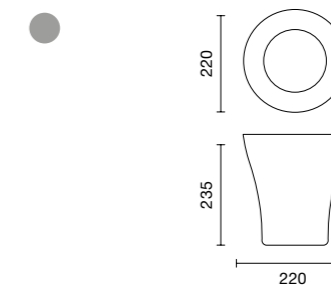
MATERIALE / MATERIAL  
Stainless steelCOLORI / COLOURS  
Inox

## NEVADA BOWL

art. 1709

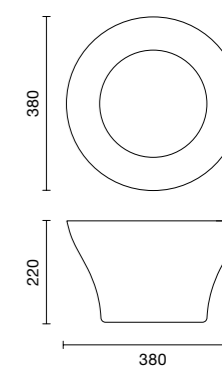
MATERIALE / MATERIAL  
Stainless steelCOLORI / COLOURS  
Inox

# Aria

*Cassa display per bottiglie, che protegge ed esalta le bottiglie di vino e spirits contenute | A bottle display case that serves to protect and highlight the wine and spirits bottles it contains*

design by LA SCENA



**IT** Aria è concepita per esaltare le bottiglie, diventando una nuova soluzione per la presentazione dei vini, realizzata in acrilico altamente trasparente. La cassa Aria può contenere fino a 6 bottiglie ed è dotata di divisori interni personalizzabili per contenere bottiglie di diverse dimensioni e forme. Senza coperchio e senza divisori interni l'oggetto diventa un'originale e pratica spumantiera per il ghiaccio, ideale per esporre le bottiglie.

**EN** Aria is designed to highlight the bottles, making it an innovative solution for the presentation of wines, made in highly transparent acrylic. This display case can contain up to 6 bottles and has internal dividers that are customizable to contain different bottle shapes and sizes. Aside from its use as a display-case, Aria becomes a practical ice-bowl for chilling and presenting wine bottles by simply removing its sliders and cover.

ARIA

art. 1900

MATERIALE / MATERIAL  
Acrilico / Acrylic

COLORI / COLOURS  
Clear

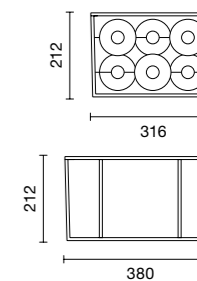

Utilizzabile come spumantiera /  
Can be used as bowl



# Wine 360°

*L'installazione sugli aromi che cambia il modo di degustare e parlare di vini e alcolici | The installation on aromas that changes the way of tasting and talking about wines and spirits*

design by WINE REVOLUTION



**IT** Wine 360° è una installazione realizzata interamente a mano che, concepita come oggetto di design e arredo e allo stesso tempo strumento didattico e mezzo di comunicazione, è pensata per esaltare le storie e le esperienze sensoriali legate a vini, alcolici e altri prodotti. La colonna, realizzata in acrilico altamente trasparente, è un display su ruote che permette di mostrare e “raccontare” il suolo, il vitigno ed il vino, mentre l’ampolla, realizzata in vetro, fa vivere una esperienza visiva, olfattiva ed emozionale unica che consente di esplorare il vino in un modo nuovo. Da oggi Wine 360° è disponibile anche nella versione Desk che coniuga l’esperienza emozionale con la praticità d’uso.

**EN** Wine 360° is a handmade installation designed as a piece of furniture, an educational and communication tool, created to enhance stories and sensorial experiences connected to wine, spirits and other products. The column, realized in highly transparent acrylic, is a wheeled display that allows to show and tell about the soil, the vines and wine. The flask, made of glass, gives a unique visual, olfactory and emotional experience that allows one to explore the wine in a new way. Wine 360° is now available in the new Desk version, a more practical version that maintains its emotional force.



WINE 360° SET

**art. 1907**

MATERIALE / MATERIAL

**Colonna: plexiglass. Ampolla: vetro /  
Column: plexiglass. Flask: glass**

COLORI / COLOURS

**Clear**

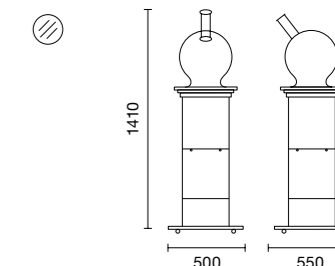

WINE 360° DESK

**art. 1911**

MATERIALE / MATERIAL

**Ampolla: vetro. Base: Acrilico /  
Flask: glass. Base: Acrylic**

COLORI / COLOURS

**Clear**

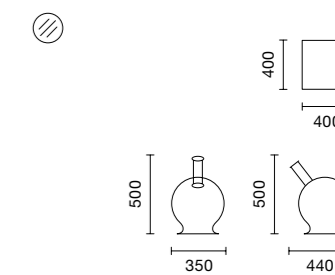

# Lollipop

*Pratico, colorato, divertente, queste le caratteristiche dello stopper Lollipop / Practical, brightly coloured, fun, these are the characteristics of the Italesse wine-stopper Lollipop*

design by MARCO ZANATTA



**IT** Realizzato in silicone in tre brillanti tonalità di colore, il tappo per bottiglie si presenta a forma di occhio circolare. Originale ed essenziale, può essere appeso al collo della bottiglia nella fase di riposo, trasformando un dettaglio estetico in dettaglio funzionale.

**EN** Realized in silicone and available in three bright colors, this wine stopper takes the form of a round loop or ring. Original and minimalist in style, it can be hung from the bottle's neck when not used, transforming an aesthetic detail into a functional feature.

LOLLIPOP

art. 1042

MATERIALE / MATERIAL  
Silicone / Silicone

COLORI / COLOURS  
White Black

Red

Red

Red

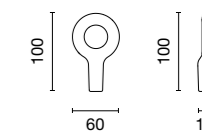

## Ocean Stopper

*Tappo funzionale, pratico e dall'appeal elegante in grado di conservare perfettamente spumanti e Champagne nel migliore dei modi | Functional, practical stopper with an elegant aesthetic that preserves the quality of Champagne and sparkling wines*

design by MINEDIVINE

OCEAN STOPPER

art. 1040

MATERIALE / MATERIAL  
 Acrilico, silicone e acciaio inox /  
 Acrylic, silicone and stainless steel

COLORI / COLOURS  
 Clear



Immagine a puro scopo esemplificativo

**IT** Questo stopper è il frutto della ricerca effettuata insieme ai migliori produttori di champagne del mercato; Italesse ha contribuito dando il suo tocco in termini di design. I materiali usati sono l'acrilico, la gomma alimentare per la tettarella e l'acciaio inox per il gancio. La particolarità della tettarella è data dal fatto che con la pressione dello champagne essa si allarga e aderisce alle pareti del collo della bottiglia, garantendo la massima tenuta.

**EN** This stopper is the result of the research made together with the best champagne producers on the market; Italesse has contributed from the design point of view. The materials used are acrylic, food-grade rubber for the teat and stainless steel for the clasp. The unique feature of the teat is that it expands under the champagne pressure and adheres to the internal walls of the bottle's mouth to guarantee an airtight seal and thus preserving the wine's sparkling properties.

## Fiesta Stopper

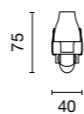
*Fiesta, divertimento ed eleganza: uno stopper completamente personalizzabile, che preserva perfettamente spumanti e Champagne | Fiesta, fun and elegance: a fully customizable stopper that perfectly preserves sparkling wines and Champagne*

design by ITALESSE

FIESTA STOPPER

art. 1043

MATERIALE / MATERIAL  
 Acrilico, silicone e acciaio inox /  
 Acrylic, silicone and stainless steel

COLORI / COLOURS  
 Clear White



Black



**IT** Fiesta Stopper conserva le proprietà delicate e gli aromi di tutte le varietà degli spumanti, grazie al suo collaudato meccanismo del gancio e alla tettarella espandibile in silicone. La sua forma richiama il tradizionale tappo da Champagne in sughero, mentre la reinterpretazione in materiale plastico gli dona un taglio decisamente contemporaneo. Nella versione Plus un'innovazione: una capocchia opzionale da inserire sulla testa dello stopper per una personalizzazione alternativa.

**EN** Fiesta Stopper preserves the delicate properties and aromas of all varieties of sparkling wine, thanks to its tried and tested hook and expandable silicone teat mechanism. Its button top evokes the traditional Champagne cork and Fiesta's interpretation in plastic material gives the accessory a contemporary edge. The Fiesta Stopper Plus model has an innovative extra feature: an optional customizable cap that can be inserted on its head offering an alternative solution for customization.

# Portfolio

Una lunga serie di marchi che pongono la qualità al centro dei propri obiettivi ha scelto Italesse per esaltare il valore delle proprie offerte e veicolare con forza la propria immagine. Tra questi, numerose catene di hotel, bar e ristoranti di lusso, produttori di wine, spirits e altre bevande. Il design e la qualità professionale dei nostri prodotti sono i punti di forza che hanno permesso la nascita di lunghe collaborazioni. Tra i vari prodotti, i nostri calici professionali sono molto apprezzati da chi fa il vino o lo valorizza alla vendita, senza dimenticare i winelovers che cercano emozioni nell'atto della degustazione. Pur essendo impossibile elencare tutti i nostri clienti, li ringraziamo tutti allo stesso modo per la fiducia che ci accordano tutti i giorni.

A long list of brands, which place quality at the center of their objectives, have chosen Italesse to enhance the value of their offers and to strongly convey their image. These include numerous chains of luxury hotels, bars and restaurants, producers of wine, spirits, and other beverages. The design and professional quality of our products are the strengths that have allowed for the emergence of long partnerships. Among the various products, our professional stem glasses are highly appreciated by those who make wine or enhance it at the sale, not to mention wine lovers who seek emotions at the time of tasting. Although it is impossible to list all our customers, we thank them all equally for the trust they place in us every day.



USA



France



United Kingdom



Sweden

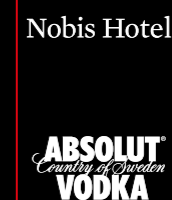

Denmark



Holland

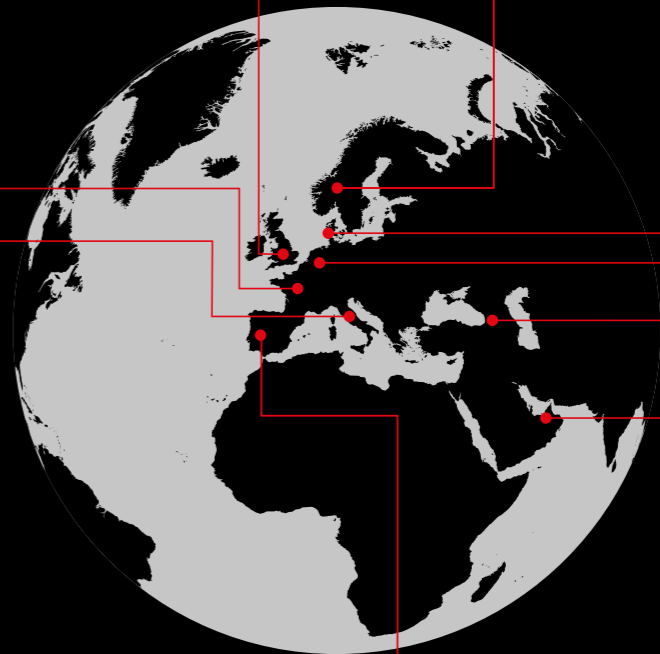

Italy



Spain



Georgia



United Arab Emirates



Japan



Hong Kong



Mexico



Brazil



Cuba

# Personalizzazioni e decorazioni / Personalization & Decoration



# **Designers & Opinion Leaders**

**Todd Bracher**

👤 Designer - Industrial and Product Design.  
 📍 New York, USA.  
 🗑️ Italesse Projects: Vas Carafe.

**Claesson Koivisto Rune**

👤 Design Studio - Industrial Design, Architecture & Interior Design, Product Design.  
 📍 Stockholm, Sweden.  
 🗑️ Italesse Projects: Richard Juhlin Optimum Champagne Glass, Tonic Glassware and Ice-Buckets.

**Minedivine**

👤 Design Studio - Industrial, Product and Graphic Design.  
 📍 Treviso, Italy.  
 🗑️ Italesse Projects: Bongo Ice-Buckets, Organica Carafe, Ocean Stopper, Sfera Glassware.

**Luca Nichetto**

👤 Designer - Industrial Design, Architecture, Product Design.  
 📍 Stockholm, Sweden.  
 🗑️ Italesse Projects: Stripe Tray, Venti4 and Fresnel Collections.

**Marco Zanatta**

👤 Designer - Product Design.  
 📍 Varese, Italy.  
 🗑️ Italesse Projects: Lollipop Stopper.

**Giancarlo Mancino**

👤 Opinion Leader - Bartender / Bar Consultant.  
 📍 Hong Kong.  
 🗑️ Italesse Projects: Wormwood Glassware.

**Richard Juhlin**

👤 Opinion Leader - Champagne Expert.  
 📍 Stockholm, Sweden.  
 🗑️ Italesse Projects: Richard Juhlin Optimum Champagne Glass.

**Maîtres Cuisiniers de France**

👤 Opinion Leader - Largest Worldwide French Chef association.  
 📍 Paris, France.  
 🗑️ Italesse Projects: Etoilé Glassware.

**Nendo**

👤 Designer - Industrial Design, Architecture, Product Design.  
 📍 Tokyo, Japan.  
 🗑️ Italesse Projects: Pebble Bowls.

**Carlos Tíscar**

👤 Designer - Industrial and Product Design.  
 📍 Valencia, Spain.  
 🗑️ Italesse Projects: Solomon Ice-Buckets.

**Luca Trazzi**

👤 Designer - Industrial and Product Design, Architecture.  
 📍 Milano, Italy.  
 🗑️ Italesse Projects: Bolle Glassware, Ice-Buckets and Accessories, Wormwood Glassware, Plaza Ice-Buckets.

**Federico Venier**

👤 Designer - Industrial Design, Architecture & Interior Design, Product Design.  
 📍 London, UK.  
 🗑️ Italesse Projects: Vinocchio and Alavin Decanters, Easy Ice-Buckets, Pagoda and Grand Pagoda Ice-Buckets.

**Luca Bini**

👤 Opinion Leader - AIS Sommelier and Hospitality Professional.  
 📍 Trento, Italy.  
 🗑️ Italesse Projects: Etoilé Sparkle Flute.

**Paolo Lauria**

👤 Marketing and Project Manager Italesse - AIS Sommelier  
 📍 Firenze, Italy  
 🗑️ Italesse Projects: Senses, Wine 360°



**Photography:**  
Thomas Zanon Larcher  
Roberto Maffioli / Italesse  
Escapista  
Azimut Photo / Massimo Gardone  
Roberto Pastrovicchio  
Rami Mansour  
Norberto Pezzotta / Visual World

**Graphic Design:**  
Fabrizio Gabrielli

**Italesse s.r.l.**

Via Dei Templari 6  
loc. Noghere – 34015 Muggia  
Trieste – Italy

**Call Center:**  
T +39 040 9235555  
F +39 040 9235251  
italesse@italesse.it

**B2B:**  
T +39 040 9235503

**Ho.Re.Ca.:**  
T +39 040 9235518

**Export:**  
T +39 040 9235508

**Marketing:**  
T +39 040 9235513  
marketing@italesse.it

italesse.com  
shop.italesse.com  
sparkle.italesse.com

© 2023

